

FLORENCE
CORPORATION

CALL US
800.275.1747

VISIT US ONLINE
FlorenceMailboxes.com



2021 FULL LINE PRODUCT CATALOG

CENTRALIZED MAIL & PACKAGE SOLUTIONS



CERTIFICATIONS



ISO 9001 Quality



ISO 14001 Environmental Management Standards

Your Trusted Partner in Centralized Mailbox Design Since 1934

Florence has been the innovator in centralized mail delivery equipment from the beginning. Since our first mailbox patent in 1934, we have developed our product lines to provide the best solutions for mail and package management systems that comply with both USPS and building regulations. Design and construction professionals know they can trust Florence to provide the right solution that complies with the requirements of the project.

Our portfolio of products covers centralized mail and package delivery applications for many different architectural styles; providing both standard pre-configured and custom configurable options in multiple popular powder coat color finishes.

As a long-time strategic supplier to the U.S. Postal Service, Florence has in-depth knowledge of postal regulations and operational requirements...making us your trusted partner! Over the last 15 years, Florence has received six separate supplier awards from the USPS including Quality Supplier, Supplier Excellence and Supplier Innovation.

With a nationwide network of Authorized Florence Dealers, you have local access to our knowledgeable product experts who can help you navigate local codes and accessibility requirements, as well as postal regulations for your new construction or renovation project.

Whether you want to do-it-yourself or prefer to have someone help you every step of the way, Florence has a solution just for you!



4

Cluster Box Units and Accessories

Pedestal-mounted Cluster Box Units are USPS-approved centralized mail delivery equipment for all residential and commercial uses

- 6 Features & Options
- 8 Cluster Box Units & Outdoor Parcel Lockers
- 9 Decorative Accessories



10

STD-4C Mailboxes and Accessories

Wall-mounted STD-4C mailboxes are USPS approved for all residential and commercial uses

- 12 Features & Options
- 14 Installation Alternatives
- 16 4C Depot Cabinets
- 17 Accessories

33

Mailbox Accessories

Accessories for mailrooms or other private applications

- 33 Key Keepers & 120 Series Collection Box
- 34 Directories

35

Replacement Mailboxes

STD-4B+ mailboxes are approved by USPS for 1:1 replacement projects or private delivery

- 36 Horizontal - Postal Delivery
- 38 Horizontal - Private Delivery
- 40 Vertical - Postal Delivery

42

Helpful Resources

- 42 Centralized Mail Delivery
- 43 Design & Service Support
- 44 Product Configurator & Architectural Resources
- 46 Replacement Parts
- 47 Important Product Info

Cluster Box Units & Outdoor Parcel Lockers

Cluster Box Unit
CBU - vital™

Cluster Box Accessories
CBU - vogue™

Outdoor Parcel Locker
OPL - valiant™



**CBU - vital™
1570-16 DB**



**CBU - vogue™
1570-8T6 V2 DB**



**OPL - valiant™
1590-T1 DB**



Florence "F" Series CBU is Officially Licensed by the US Postal Service



The Florence vital™ 1570 series CBU line is an Officially Licensed CBU product of the US Postal Service for centralized mail delivery.

License #3DVDIE-16-B-0063

Thoughtful planning ensures CBUs blend nicely into your community, creating a common gathering space for you and your neighbors

Conveniently located in a centralized area of your single or multifamily community

Furnishing residents with secure, cost effective solutions for mail and package delivery

Providing most efficient method of mail and package delivery to your community

Decorative accessories dress up standard units to complement your community's architectural style

Florence Dealers provide turnkey solutions, integrating USPS Approved Cluster Box Units & Outdoor Parcel Lockers into your community





See how proper planning mixed with good design results in beautiful communities.

Visit www.florencemailboxes.com/case-studies

Cluster Box Units

FEATURES & OPTIONS

CBU STANDARD COMPARTMENT SIZES

All CBU models are USPS Approved and pre-configured with standard tenant and parcel locker compartment heights which meet specific USPS regulations.

Note: All OPL parcel locker compartments are 19-5/8" H x 12" W

Tenant Compartment
3" H x 12" W



Parcel Locker Compartment
9-7/8" H x 12" W

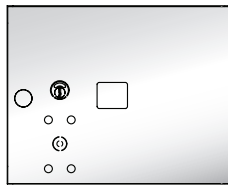

Tenant Compartment
4-3/4" H x 12" W



Parcel Locker Compartment
13-3/8" H x 12" W

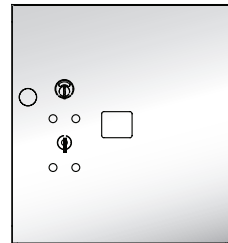

Double High Tenant Compartment
6-1/2" H x 12" W

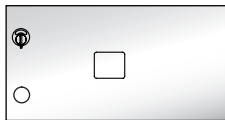

DOOR ID OPTIONS

Decals: All CBUs come standard with silver adhesive decals which are 1-1/2"H x 1-3/4"W. Black lettering can contain up to five characters (alpha and numeric) per decal.

Engraving: Custom engraving utilizes the USPS Standard US Block font and is 3/4" tall. All engraving can include up to 12 characters on one or two lines.



COLOR OPTIONS

All cluster box unit types are available in six different architectural color options; all in a durable, powder coat finish.



Black (BK)



Dark Bronze (DB)

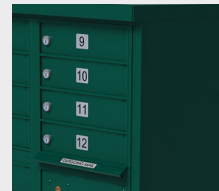

Forest Green (FG)



Sandstone (SD)



White (WH)



Postal Grey* (PG)

*Note: Postal Grey is USPS Approved for replacement only and is not intended for new installations.

Cluster Box Units

PRODUCT DESIGN & SECURITY FEATURES



Sloped top for moisture runoff



Standard silver adhesive identification decals contain up to five characters (engraving optional)



Fully integrated parcel locker(s) with key trapping lock



Easy release handle to open master gate



Heavy-duty tenant cam lock with three keys

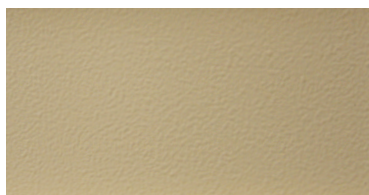

Rugged, weather-resistant powder coat finish in six architectural colors



Interlocking, overlapping seams and tight clearances to prevent prying



Integrated Outgoing Mail Slot with weather protection hood



Convenient solid aluminum integrated outgoing mail collection compartment prepped for USPS Arrow Lock



Stainless steel hold open door catch on each side of master gate



Aluminum comb prevents mail fishing in outgoing mail collection compartment



Heavy duty cam latches through frame for added security

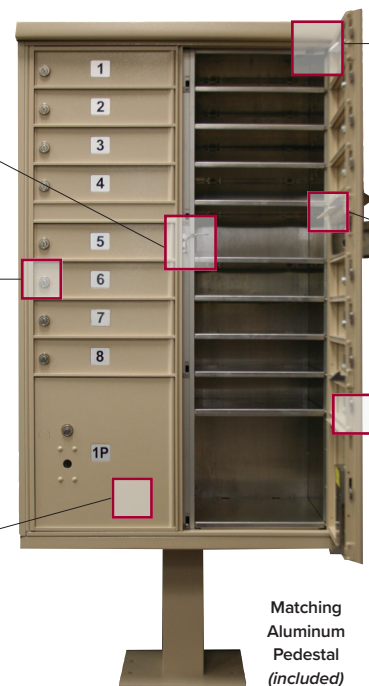

Matching Aluminum Pedestal (included)

vital™ Cluster Box Units

Pre-configured units include parcel lockers and outgoing mail collection to be used alone or in large groupings. Pedestal included ensures mailboxes and parcel lockers comply with USPS installation regulations. Available in six architectural colors (see page 6).

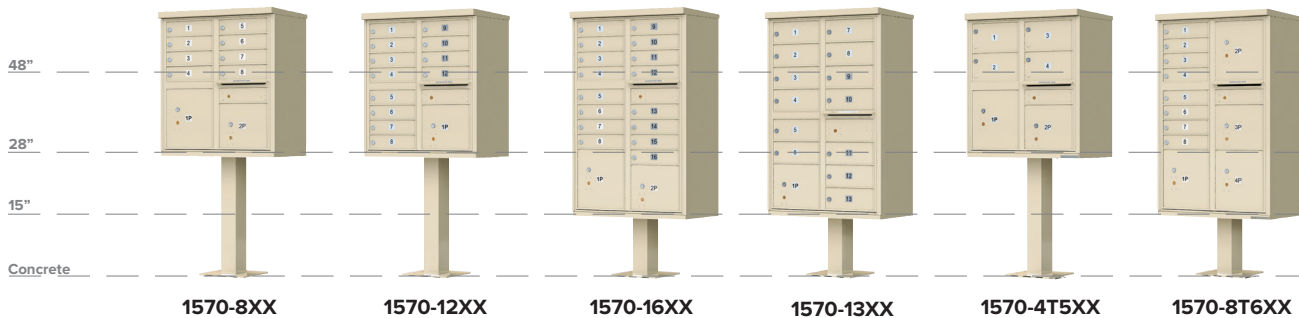

MODEL #	CBU TYPE	INSTALLED HEIGHT	INSTALLED WIDTH	INSTALLED DEPTH	PEDESTAL HEIGHT	WEIGHT (LBS)	STANDARD TENANT COMPARTMENT DIMENSIONS	MAILBOX COMPARTMENTS	PARCEL LOCKERS
1570-8XX	vital™ Type I CBU	62"	30-1/2"	18"	28-1/2"	144	3"H x 12"W x 15"D	8	2
1570-12XX	vital™ Type II CBU	62"	30-1/2"	18"	28-1/2"	144	3"H x 12"W x 15"D	12	1
1570-16XX	vital™ Type III CBU	62"	30-1/2"	18"	14-1/2"	175	3"H x 12"W x 15"D	16	2
1570-13XX	vital™ Type IV CBU	62"	30-1/2"	18"	14-1/2"	167	4-3/4"H x 12"W x 15"D	13	1
1570-4T5XX	vital™ Type V CBU	62"	30-1/2"	18"	28-1/2"	145	6-1/2"H x 12"W x 15"D	4	2
1570-8T6XX	vital™ Type VI CBU	62"	30-1/2"	18"	14-1/2"	176	3"H x 12"W x 15"D	8	4

Note: Exchange "XX" in Model # above for two-digit color reference: Black=BK Dark Bronze=DB Sandstone=SD Postal Grey=PG White = WH Forest Green = FG

valiant™ Outdoor Parcel Lockers

Industry unique package delivery system with key trapping locks can be used alone or with CBU installation to accommodate USPS-delivered packages in a secure locker.

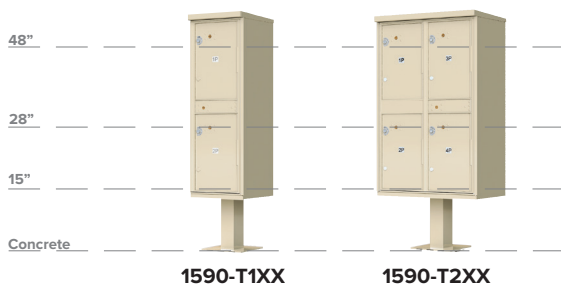

Florence "F" Series CBU is Officially Licensed by the US Postal Service

The Florence vital™ 1570 series CBU line is an Officially Licensed CBU product of the US Postal Service for centralized mail delivery.

License #3DVDIE-16-B-0063

MODEL #	OPL TYPE	INSTALLED HEIGHT	INSTALLED WIDTH	INSTALLED DEPTH	PEDESTAL HEIGHT	WEIGHT (LBS)	STANDARD TENANT COMPARTMENT DIMENSIONS	MAILBOX COMPARTMENTS	PARCEL LOCKERS
1590-T1XX	valiant™ Type I OPL	62"	16"	18"	14-1/2"	100	19-5/8"H x 12"W x 15"D	0	2
1590-T2XX	valiant™ Type II OPL	62"	30-1/2"	18"	14-1/2"	139	19-5/8"H x 12"W x 15"D	0	4

Note: Exchange "XX" in Model # above for two-digit color reference: Black=BK Dark Bronze=DB Sandstone=SD Postal Grey=PG White = WH Forest Green = FG

vogue™ Cluster Box Accessories

Dress up the basic CBU and OPL with decorative accessories to complement your neighborhood. Color coordinating caps and pedestal covers are offered in two styles.



CLASSIC



TRADITIONAL



MODEL #	CBU/VOGUE COMBO TYPE	INSTALLED HEIGHT	INSTALLED WIDTH	INSTALLED DEPTH	WEIGHT (LBS)	STANDARD TENANT COMPARTMENT DIMENSIONS	MAILBOX COMPARTMENTS	PARCEL LOCKERS
1570-8VXX	Classic Type I CBU Combo	65-1/8"	33-7/8"	21-3/8"	182	3"H x 12"W x 15"D	8	2
1570-12VXX	Classic Type II CBU Combo	65-1/8"	33-7/8"	21-3/8"	182	3"H x 12"W x 15"D	12	1
1570-16VXX	Classic Type III CBU Combo	65-1/8"	33-7/8"	21-3/8"	206	3"H x 12"W x 15"D	16	2
1570-13VXX	Classic Type IV CBU Combo	65-1/8"	33-7/8"	21-3/8"	198	4-3/4"H x 12"W x 15"D	13	1
1570-4T5VXX	Classic Type V CBU Combo	65-1/8"	33-7/8"	21-3/8"	183	6-1/2"H x 12"W x 15"D	4	2
1570-8T6VXX	Classic Type VI CBU Combo	65-1/8"	33-7/8"	21-3/8"	207	3"H x 12"W x 15"D	8	4
1590-T1VXX	Classic Type I OPL Combo	65-1/8"	19-5/8"	21-3/8"	124	N/A	0	2
1590-T2VXX	Classic Type II OPL Combo	65-1/8"	33-7/8"	21-3/8"	182	N/A	0	4
1570-8V2XX	Traditional Type I CBU Combo	71-3/8"	31-5/8"	18-1/2"	177	3"H x 12"W x 15"D	8	2
1570-12V2XX	Traditional Type II CBU Combo	71-3/8"	31-5/8"	18-1/2"	177	3"H x 12"W x 15"D	12	1
1570-16V2XX	Traditional Type III CBU Combo	71-3/8"	31-5/8"	18-1/2"	203	3"H x 12"W x 15"D	16	2
1570-13V2XX	Traditional Type IV CBU Combo	71-3/8"	31-5/8"	18-1/2"	195	4-3/4"H x 12"W x 15"D	13	1
1570-4T5V2XX	Traditional Type V CBU Combo	71-3/8"	31-5/8"	18-1/2"	178	6-1/2"H x 12"W x 15"D	4	2
1570-8T6V2XX	Traditional Type VI CBU Combo	71-3/8"	31-5/8"	18-1/2"	204	3"H x 12"W x 15"D	8	4
1590-T1V2XX	Traditional Type I OPL Combo	71-3/8"	17-3/8"	18-1/2"	119	N/A	0	2
1590-T2V2XX	Traditional Type II OPL Combo	71-3/8"	31-5/8"	18-1/2"	178	N/A	0	4

Note: Exchange "XX" in Model # above for two-digit color reference: Black=BK Dark Bronze=DB Sandstone=SD Postal Grey=PG White = WH Forest Green = FG

STD-4C Mailboxes & Parcel Lockers

FLEXIBILITY TO MEET YOUR NEEDS

versatile™
4C Mailbox
Suites



Versatility is the key to good design when planning for single or multifamily residential or commercial projects

Both preconfigured designs and customizable configurations make it easy to design a centralized mail area just right for your project

USPS Approved and ADA Compliant designs are critical components of a functional mailroom

Online resources provide a design configurator, BIM models and specifications easily accessible for download into your project plans

Secure solutions for mail and package delivery are important to residents

Florence Dealers provide turnkey solutions, integrating USPS Approved STD-4C Mailbox Suites into your next project





From ordinary to visionary.

Visit *Architect Toolkit* for
more ideas and resources.
[www.florencemailboxes.com/
architecttoolkit](http://www.florencemailboxes.com/architecttoolkit)

versatile™ 4C Mailboxes & Parcel Lockers

FEATURES & OPTIONS

MAIL, OUTGOING MAIL & PARCEL LOCKER COMPARTMENT SIZES

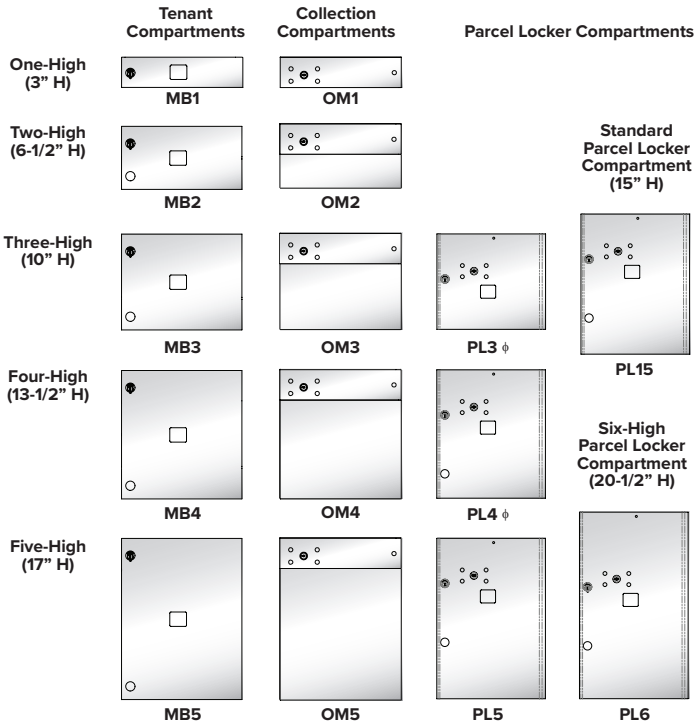

ϕ For Private Delivery, unless parcel locker ratio exceeds requirement - see below for full details

ϕ To satisfy the USPS STD-4C 1:5 parcel locker to mailbox ratio requirement, parcel lockers (PL) must meet a minimum compartment height of 15". If the total number of PL in the mailbox installation exceeds the 1:5 requirement, smaller PL may also be included. For example: If a project requires 200 mailboxes, then at least 40 PL with a minimum size of 15"H x 12"W x 15"D must be included. But, if you add more than 40 PL to the 200 mailboxes, then you may also choose to incorporate some smaller PL into the installation. Be sure to note PL height when utilizing only one 4C module type in your entire installation as not all built-in lockers are 15" H and may require addition of parcel only modules to meet the 1:5 requirements (e.g. 4C13D-16).

DOOR ID OPTIONS

Decals: All 4C modules come standard with silver adhesive decals which are 1-1/2"H x 1-3/4"W. Black lettering can contain up to five characters (alpha and numeric) per decal.

Engraving: Custom engraving utilizes the USPS Standard US Block font and is 3/4" tall. All engraving can include up to 12 characters on one or two lines.



1:5 PARCEL LOCKER TO CUSTOMER COMPARTMENT RATIO REQUIRED BY USPS

COLOR OPTIONS

Customize your 4C module with one of eight different architectural color options, all in a durable, powder coat finish.



Antique Bronze (AB) Black (BK) Dark Bronze (DB) Gold Speck (GS)



Postal Grey (PG) Sandstone (SD) Silver Speck (SS) White (WH)

Colors shown are representative of the actual powder coat finish but are limited by printing conditions and may vary slightly from finished product.

PRODUCT DESIGN & SECURITY FEATURES



Interlocking, overlapping seams to prevent prying



Heavy duty tenant cam lock with three keys

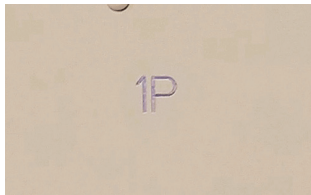

Standard decals or 3/4" H engraving

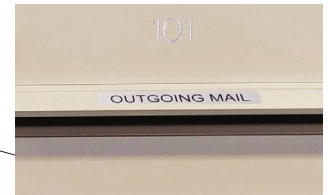
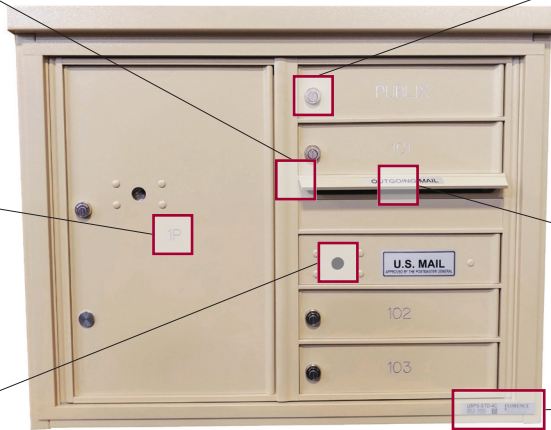

Integrated Outgoing Mail Slot with weather protection hood



Solid aluminum integrated outgoing mail collection compartment prepared for USPS installed Arrow Lock



Product and manufacturer ID serial tag



Fully integrated parcel locker(s) with key trapping lock



Stainless steel hold open door catch on each side of master gate



Easy release handle to open master gate



Aluminum comb prevents mail fishing in outgoing mail collection compartment

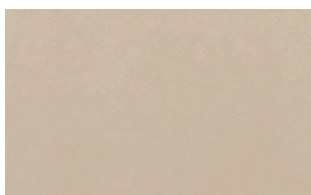

Rugged, weather-resistant powder coat finish



Heavy duty cam latches through frame for added security

Installation Alternatives

OPTIONS FOR STD-4C MOUNTING

RECESSED MOUNT

The most common way to install the 4C modules is into a wall. Florence makes installation easy by providing a Multi-Unit Connector Kit (MUCK) for each specified module. The MUCK eliminates the need for studs and pulls the units together tightly, reducing any potential gaps between modules.

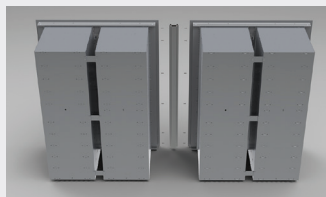

SURFACE MOUNT

Single or double-wide 4C modules can be installed flush on a wall when utilizing the surface-mount collar option. This installation alternative is ideal for settings with limited wall depth. The collar is easy to assemble with a slotted back which is designed for ease of installation. The collars are all aluminum construction in rugged, weather-resistant powder coat finishes and can be used indoors or out.



SM##D SM##S
(Note: ## = selected suite height, e.g. SM14D)



FREESTANDING CABINET MOUNT

The Depot is a freestanding solution that provides flexibility to install our most popular 4C mailboxes in a standalone cabinet when wall space is limited. Depots are designed to ensure the selected module is installed at a standard accessible height. Ease of installation also makes the freestanding Depot option a popular choice. To order, add -D to 4C model number. (Example: 4C16D-20-D)



Surface-Mount Collars

Designed for indoor use, Florence is pleased to offer a heavy-duty STD-4C mailbox enclosure which allows modules to quickly and easily be mounted to any flat surface. This smooth aluminum collar ensures the mail system achieves that desired sleek, finished look while easily attaching directly to the mailbox module. Ideal for settings with limited wall depth, this USPS-approved solution provides greater flexibility in your mailbox placement and installation.

STANDARD FEATURES

- Available for all 4C modules
- Eight powder coat color finishes
- Order separately SMS##D or SM##S
(Note ## = selected suite heigh, e.g. SM16D)

SURFACE MOUNT CABINET COLLAR DIMENSIONS

DOUBLE WIDE - SM##D = 32-3/8" W
SINGLE WIDE - SM##S = 18-5/16" W

SUITE HEIGHT	SM CABINET HEIGHT
Max Height	57-11/16" H
15H	55-15/16" H
14H	52-7/16" H
13H	48-15/16" H
12H	45-7/16" H
11H	38-7/16" H
10H/ADA	34-15/16" H
9H	34-15/16" H
8H	31-7/16" H
7H	27-15/16" H
6H	24-7/16" H



COLOR OPTIONS

Customize your versatile™ 4C Surface Mount Cabinet with eight different architectural powder coat finishes.



Antique
Bronze (AB)

Black
(BK)

Dark Bronze
(DB)

Gold Speck
(GS)



Postal Grey
(PG)

Sandstone
(SD)

Silver Speck
(SS)

White
(WH)

Colors shown are representative of the actual powder coat finish but are limited by printing conditions and may vary slightly from finished product.

versatile™
4C mailboxes &
parcel lockers

PRODUCT SELECTIONS

4C Depot Cabinet

FOR INSTALLATION FLEXIBILITY

The Depot is a freestanding solution that provides flexibility to install our most popular 4C mailboxes in a standalone cabinet when space is limited. Depots are designed to ensure the selected module is installed at a standard accessible height in compliance with USPS installation guidance. Ease of installation also makes the freestanding Depot cabinet a popular choice. To order, add -D to 4C model number. (Example: 4C16D-20-D)

STANDARD FEATURES

- Available to fit our most popular 4C modules - MAX Height, 15H, ADA and 6H
- Weather resistant design makes the Depot suitable for use indoor or out
- All aluminum, corrosion resistant construction
- Sloped top for moisture runoff
- Eight powder coat finishes
- Depot cabinet and 4C ship fully assembled
- Adjustable leveling legs ensure the unit is level even when the floor is not
- Ease of installation means there's no need to remove the 4C from the Depot in order to install

4C DEPOT CABINET SELECTIONS

See 4C Suites on the following pages. Depot cabinets shown below accommodate all modules 6, ADA, 15 and 16 high 4C Suites. To order, simply add "D" to 4C model numbers. For example, a 16-High 20 mailbox module = 4C16D-20-D



COLOR OPTIONS

Customize your versatile™ 4C Depot Cabinet with eight different architectural powder coat finishes.



Antique Bronze (AB) Black (BK) Dark Bronze (DB) Gold Speck (GS)



Postal Grey (PG) Sandstone (SD) Silver Speck (SS) White (WH)

Colors shown are representative of the actual powder coat finish but are limited by printing conditions and may vary slightly from finished product.

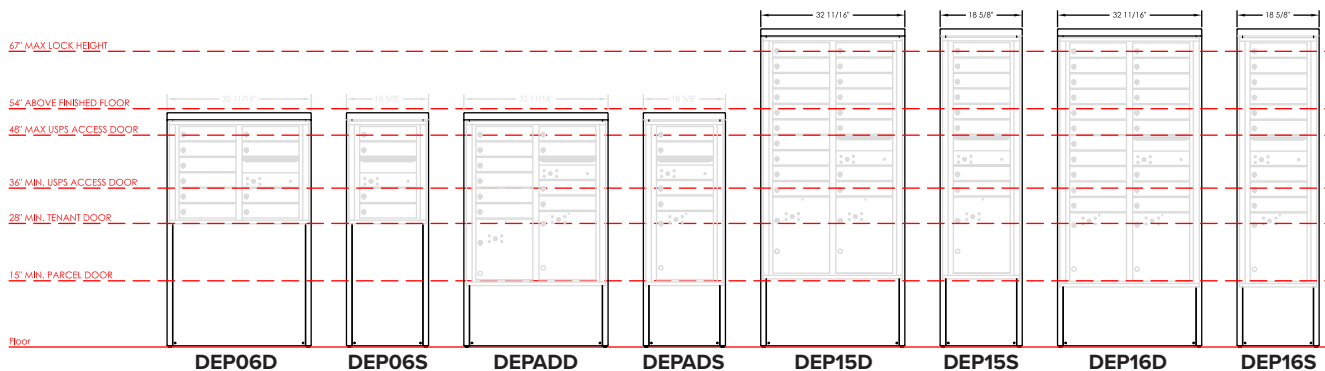

PRODUCT SELECTIONS

AVAILABLE IN 12 DIFFERENT HEIGHT OPTIONS

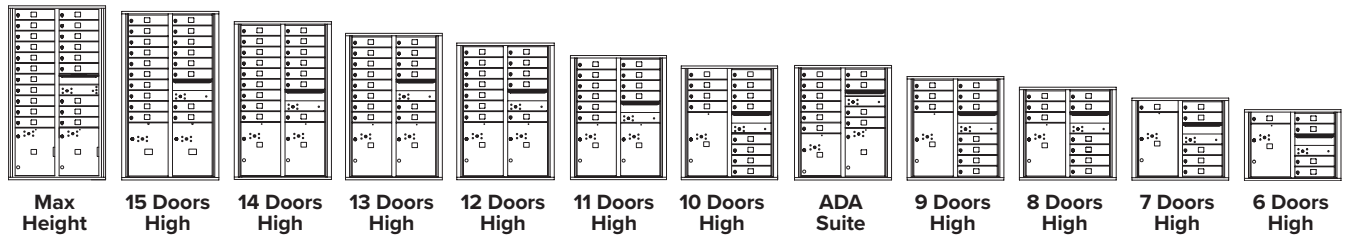

The reference module images and charts on the following pages show the proper installation heights for Florence's versatile™ 4C mailboxes and parcel lockers to help your project comply with USPS installation and accessibility codes. Drawings shown are for your quick reference only. See following pages for details.

OPTIONAL ACCESSORIES



Collection Boxes *See page 18*

These secure collection modules complement your mailbox installation and are designed for either postal or private collection of items such as x-rays, DVD/Blue Ray, books, etc.



Recycling Bins *See page 19*

Keep the centralized mail center tidy by providing receptacles for the disposal of unwanted mail, or create a recycling center with these matching modules.



Key Keepers *See page 34*

Key Keepers are prepared to accept a postal lock installed by local postal officials, providing secure access to important keys.



Directories *See page 35*

These surface-mounted directories can be used independently or installed next to any mailbox installation to neatly and alphabetically list the names of your residents. A clear plastic window, metal back plate, and blank ruled name cards are included with each directory.

TOP/SIDE VIEWS FOR ALL HEIGHTS

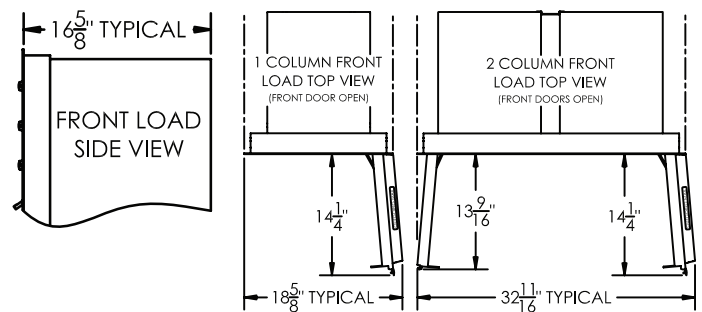

Collection Boxes FOR LETTERS OR PACKAGES

Use this secure product for the collection of outgoing mail in the form of letters or small packages. The patent pending hopper mechanism and collection box door ensure contents remain safe and secure. Designed to be suitable for indoor or outdoor use, it can be mounted on a pedestal, in a wall or on the surface of the wall.



4C10S-HOP

STANDARD FEATURES

- Recess mount
- ADA/DOJ, ICC/ANSI and IBC compliant for maximum 48" door access when installed 14-1/8" AFF.
- When open, collection door extends 5-7/16" from unit and seals off access to the main collection compartment to prevent mail fishing. Once unit is full, collection door will not open to accept more items.

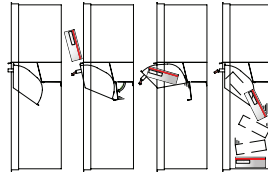

OPTIONAL FEATURES

- Surface mount available for all units
- Freestanding depot option available for select units (4C16S-HOP-D, 4C15S-HOP-D, 4CADS-HOP-D)



4C16S-HOP

4C15S-HOP

4C14S-HOP

4C13S-HOP

4C12S-HOP

4C11S-HOP

4CADS-HOP

4C09S-HOP

4C08S-HOP

COLOR OPTIONS

Customize your versatile™ Collection Boxes with eight different architectural powder coat finishes.



Antique Bronze (AB)

Black (BK)

Dark Bronze (DB)

Gold Speck (GS)



Postal Grey (PG)

Sandstone (SD)

Silver Speck (SS)

White (WH)

Colors shown are representative of the actual powder coat finish but are limited by printing conditions and may vary slightly from finished product.

COLLECTION BOX SELECTIONS

Designed to coordinate with versatile™ 4C mailbox suites, select as many modules as needed for your project.

Collection Bins FOR WASTE/RECYCLING

These bins are designed as part of the versatile™ 4C mailbox line and are the perfect complement to your centralized mail center. Keep the area tidy by providing receptacles for the disposal of waste, or create a standalone recycling center for the convenience of your residents.



STANDARD FEATURES

- Recess mount
- Cabinet door includes 5-pin cam lock with three keys
- Stainless steel door flap with decals; choice of: WASTE, TRASH, PLASTIC, GLASS or PAPER
- Interior collection receptacles are included and constructed of all recycled materials

OPTIONAL FEATURES

- Surface mount available for all units
- Freestanding depot option available for select units (4C16S-BIN-D, 4C15S-BIN-D, 4CADS-BIN-D)
- Custom door flap decals with up to 12 characters
- Powder coat finish door flap in coordinating color



COLOR OPTIONS

Customize your versatile™ Collection Bin with eight different architectural powder coat finishes.

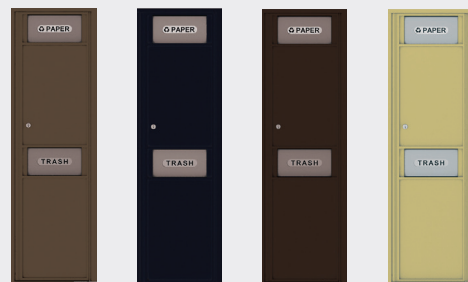

Antique Bronze (AB) Black (BK) Dark Bronze (DB) Gold Speck (GS)



Postal Grey (PG) Sandstone (SD) Silver Speck (SS) White (WH)

Colors shown are representative of the actual powder coat finish but are limited by printing conditions and may vary slightly from finished product.

BIN SELECTIONS

Designed to coordinate with the versatile™ 4C mailbox suites, select as many modules as needed for your project.

MAX HEIGHT SUITE

Actual: 56-1/2"H x 31-9/16"W (Double) or 17-1/2"W (Single) x 17"D
 Rough Opening: 55-9/16"H x 30-5/16"W (Double) or 16-1/4"W (Single) x 17"D
 Full suite also available in freestanding Depot cabinet

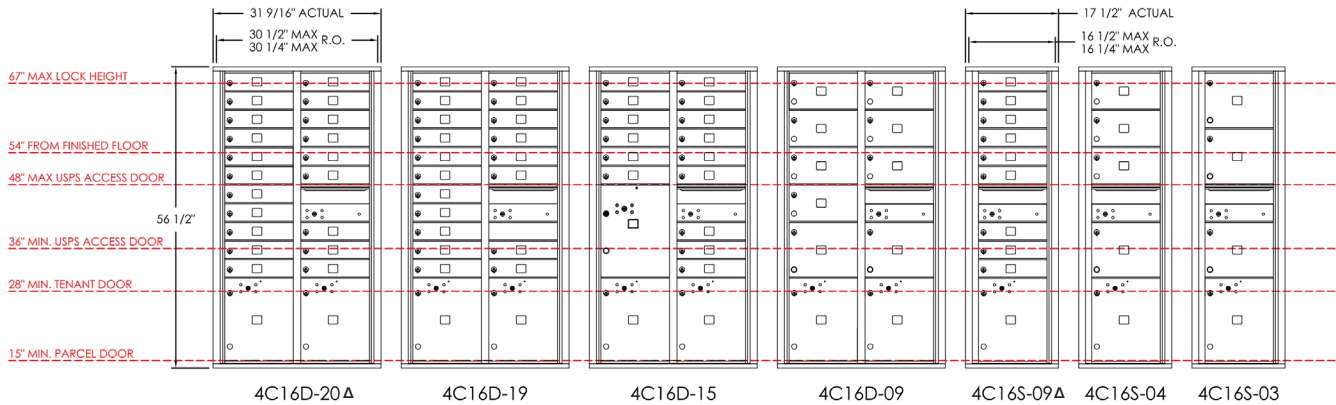

Floor

MODEL (COMPARTMENT TYPES)	4C16D-20 Δ (20 MB1, 2 PL15)	4C16D-19 (19 MB1, 2 PL15)	4C16D-15 (15 MB1, 2 PL15, 1 PL5)	4C16D-09 (7 MB2, 2 MB3, 2 PL15)	4C16S-09 Δ (9 MB1, 1 PL15)	4C16S-04 (3 MB2, 1 MB3, 1 PL15)	4C16S-03 (3 MB3, 1 PL15)
# Mailboxes (Total)	20	19	15	9	9	4	3
# Parcel Lockers (Total)	2	2	3	2	1	1	1
# Collection	1	1	1	1	1	1	1
# BINS	0	0	0	0	0	0	0
# Mailboxes Under 48"	8	7	3	3	3	1	1
Module Weight (lbs)	171	163	160	157	97	81	62

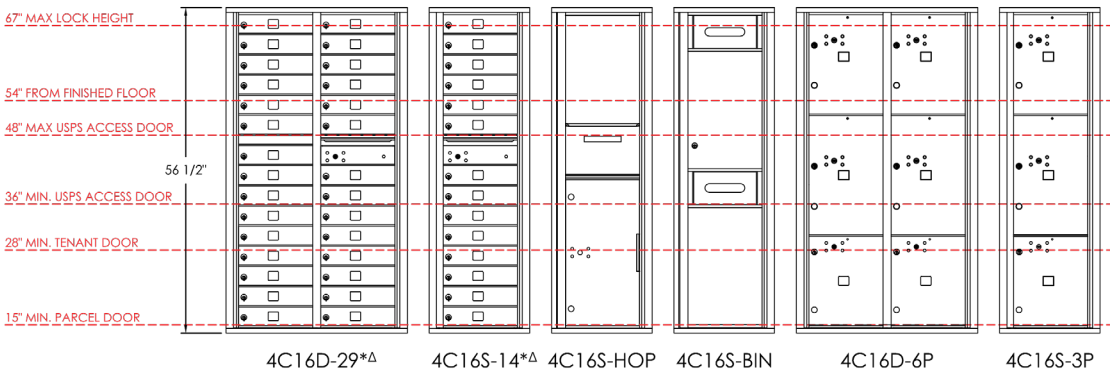

Floor

MODEL (COMPARTMENT TYPES)	4C16D-29* Δ (29 MB1)	4C16S-14* Δ (14 MB1)	4C16S-HOP	4C16S-BIN	4C16D-6P (2 PL15, 2 PL5, 2 PL6)	4C16S-3P (1 PL15, 1 PL5, 1 PL6)
# Mailboxes (Total)	29	14	0	0	0	0
# Parcel Lockers (Total)	0	0	0	0	6	3
# Collection	1	1	1	0	0	0
# BINS	0	0	0	2	0	0
# Mailboxes Under 48"	17	8	0	0	0	0
Module Weight (lbs)	170	96	76	65	105	58

NOTES:

- See page 12 for mailbox (MB) and parcel locker (PL) compartment size definitions and configurable options. Key to module notations are as follows:
- Δ Modules are configurable. Visit florencemailboxes.com/configure to create your custom solution
- * Modules do not meet USPS installation specifications and are for private delivery.
- φ Modules contain PL under the USPS required 15" tall minimum
- + Modules meet ADA upper reach limit of 48" FFF when installed at recommended height
- # Modules meet Fair Housing side reach limit of 54" FFF when installed at recommended height

versatile™
4C mailboxes &
parcel lockers

15 DOOR HIGH SUITE

Actual: 54-3/4"H x 31-9/16"W (Double) or 17-1/2"W (Single) x 17"D
Rough Opening: 53-13/16"H x 30-5/16"W (Double) or 16-1/4"W (Single) x 17"D
Full suite also available in freestanding Depot cabinet

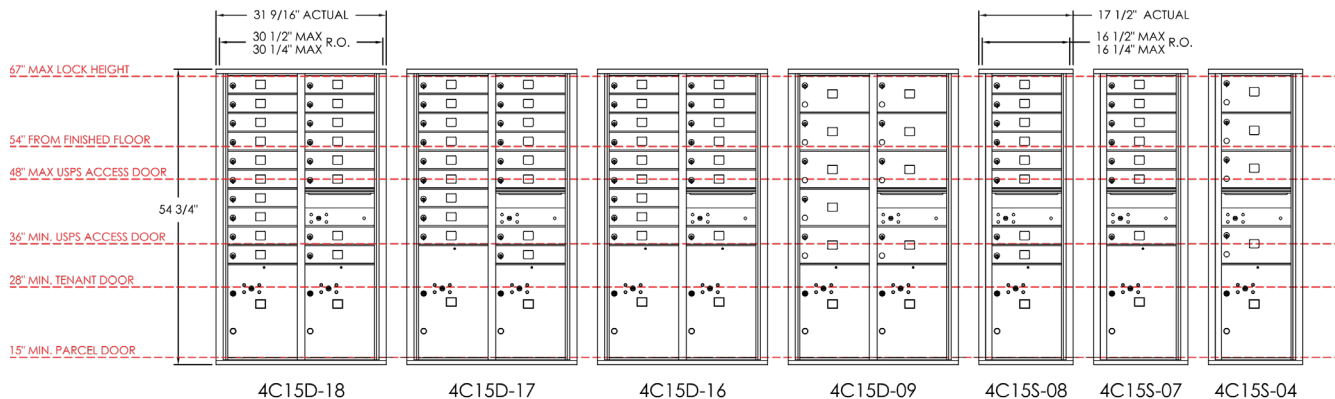

Floor

MODEL (COMPARTMENT TYPES)	4C15D-18 (18 MB1, 2 PL5)	4C15D-17 (17 MB1, 1 PL5, 1 PL6)	4C15D-16 (16 MB1, 2 PL6)	4C15D-09 (9 MB2, 2 PL5)	4C15S-08 (8 MB1, 1 PL5)	4C15S-07 (7 MB1, 1 PL6)	4C15S-04 (4 MB2, 1 PL5)
# Mailboxes (Total)	18	17	16	9	8	7	4
# Parcel Lockers (Total)	2	2	2	2	1	1	1
# Collection	1	1	1	1	1	1	1
# BINS	0	0	0	0	0	0	0
# Mailboxes Under 48"	8	7	6	3	3	2	1
Module Weight (lbs)	160	158	156	144	87	85	79

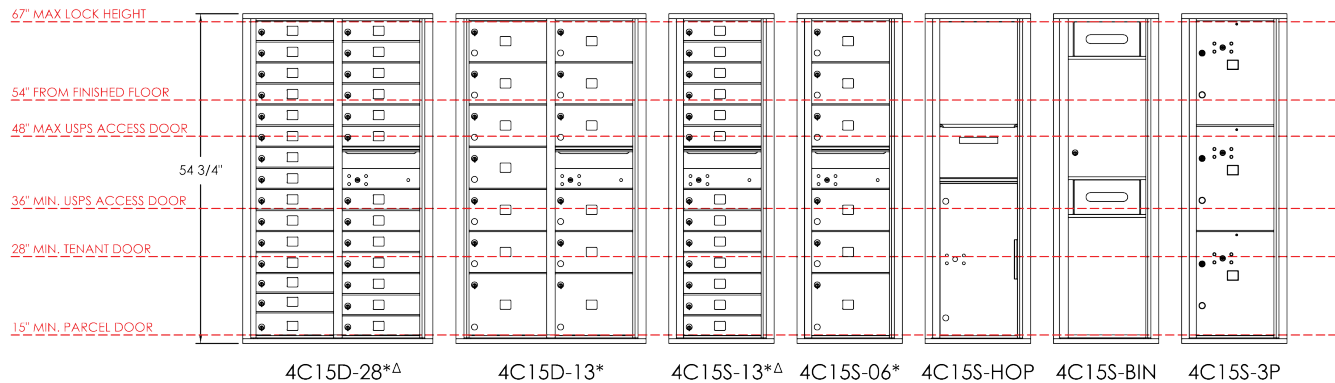

Floor

MODEL (COMPARTMENT TYPES)	4C15D-28*Δ (28 MB1)	4C15D-13* (11 MB2, 2 MB3)	4C15S-13*Δ (13 MB1)	4C15S-06* (5 MB2, 1 MB3)	4C15S-HOP	4C15S-BIN	4C15S-3P (3 PL5)
# Mailboxes (Total)	28	13	13	6	0	0	0
# Parcel Lockers (Total)	0	0	0	0	0	0	3
# Collection	1	1	1	1	1	0	0
# BINS	0	0	0	0	0	2	0
# Mailboxes Under 48"	18	7	8	3	0	0	0
Module Weight (lbs)	122	142	95	79	74	63	75

NOTES:

See page 12 for mailbox (MB) and parcel locker (PL) compartment size definitions and configurable options. Key to module notations are as follows:

Δ Modules are configurable. Visit florencemailboxes.com/configure to create your custom solution

* Modules do not meet USPS installation specifications and are for private delivery.

φ Modules contain PL under the USPS required 15" tall minimum

+ Modules meet ADA upper reach limit of 48" FFF when installed at recommended height

Modules meet Fair Housing side reach limit of 54" FFF when installed at recommended height

14 DOOR HIGH SUITE

Actual: 51-1/4"H x 31-9/16"W (Double) or 17-1/2"W (Single) x 17"D
Rough Opening: 50-5/16"H x 30-5/16"W (Double) or 16-1/4"W (Single) x 17"D

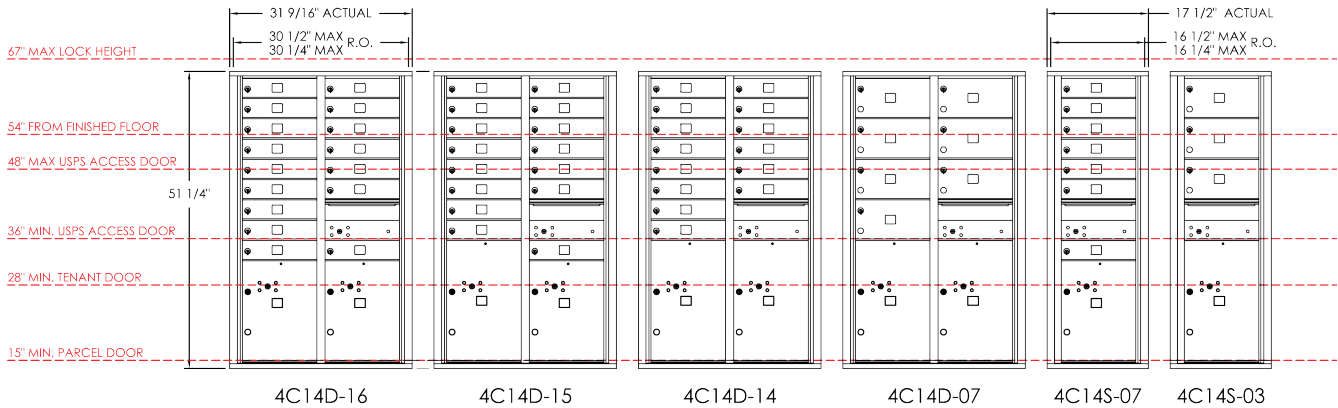

Floor

MODEL (COMPARTMENT TYPES)	4C14D-16 (16 MB1, 2 PL5)	4C14D-15 (15 MB1, 1 PL5, 1 PL6)	4C14D-14 (14 MB1, 2 PL6)	4C14D-07 (7 MB2, 2 PL6)	4C14S-07 (7 MB1, 1 PL5)	4C14S-03 (3 MB2, 1 PL6)
# Mailboxes (Total)	16	15	14	7	7	3
# Parcel Lockers (Total)	2	2	2	2	1	1
# Collection	1	1	1	1	1	1
# BINS	0	0	0	0	0	0
# Mailboxes Under 48"	8	7	6	3	3	1
Module Weight (lbs)	137	130	109	99	72	56

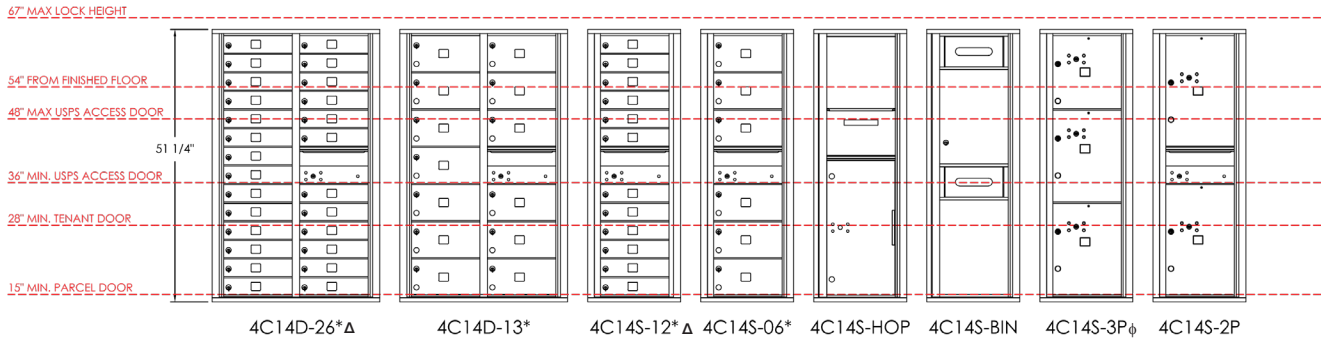

Floor

MODEL (COMPARTMENT TYPES)	4C14D-26*Δ (26 MB1)	4C14D-13* (13 MB2)	4C14S-12*Δ (12 MB1)	4C14S-06* (6 MB2)	4C14S-HOP	4C14S-BIN	4C14S-3Pφ (1 PL4, 2 PL5)	4C14S-2P (2 PL6)
# Mailboxes (Total)	26	13	12	6	0	0	0	0
# Parcel Lockers (Total)	0	0	0	0	0	0	3	2
# Collection	1	1	1	1	1	0	0	1
# BINS	0	0	0	0	0	2	0	0
# Mailboxes Under 48"	18	9	8	4	0	0	0	0
Module Weight (lbs)	145	101	76	56	72	58	56	55

NOTES:

See page 12 for mailbox (MB) and parcel locker (PL) compartment size definitions and configurable options. Key to module notations are as follows:

Δ Modules are configurable. Visit florencemailboxes.com/configure to create your custom solution

* Modules do not meet USPS installation specifications and are for private delivery.

φ Modules contain PL under the USPS required 15" tall minimum

+ Modules meet ADA upper reach limit of 48" FFF when installed at recommended height

Modules meet Fair Housing side reach limit of 54" FFF when installed at recommended height

13 DOOR HIGH SUITE

Actual: 47-3/4"H x 31-9/16"W (Double) or 17-1/2"W (Single) x 17"D
Rough Opening: 46-13/16"H x 30-5/16"W (Double) or 16-1/4"W (Single) x 17"D

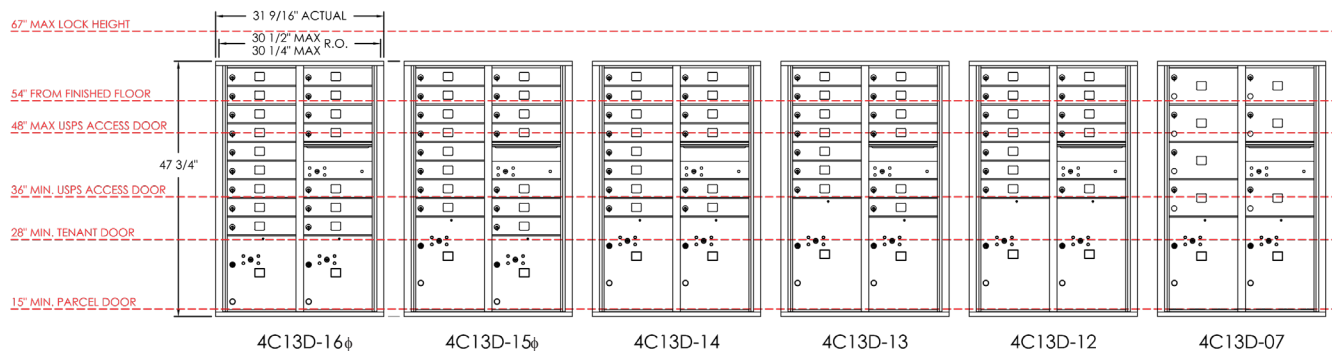

Floor

MODEL (COMPARTMENT TYPES)	4C13D-16 φ (16 MB1, 2 PL4)	4C13D-15 φ (15 MB1, 1 PL 4, 1 PL5)	4C13D-14 (14 MB1, 2 PL5)	4C13D-13 (13 MB1, 1 PL5, 1 PL6)	4C13D-12 (12 MB1, 2 PL6)	4C13D-07 (7 MB2, 2 PL5)
# Mailboxes (Total)	16	15	14	13	12	7
# Parcel Lockers (Total)	2	2	2	2	2	2
# Collection	1	1	1	1	1	1
# BINS	0	0	0	0	0	0
# Mailboxes Under 48"	10	9	8	7	6	3
Module Weight (lbs)	129	127	125	123	121	114

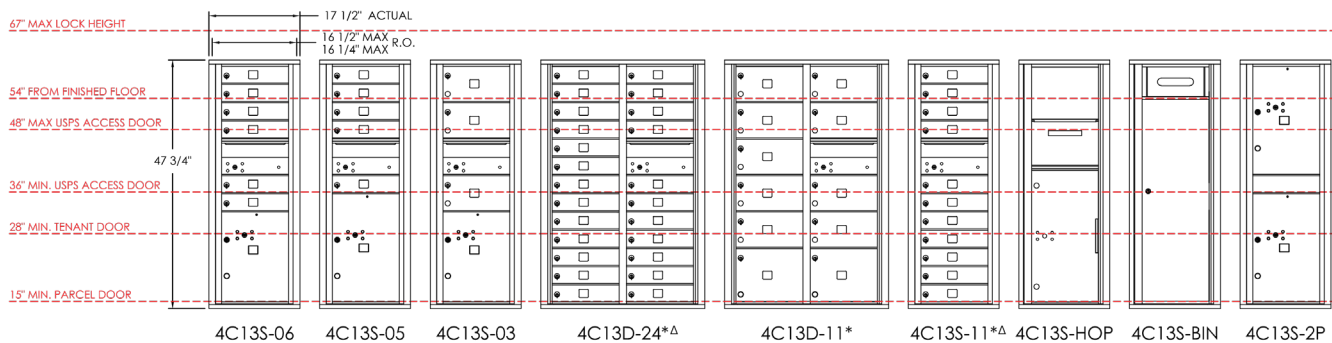

Floor

MODEL (COMPARTMENT TYPES)	4C13S-06 (6 MB1, 1 PL5)	4C13S-05 (5 MB1, 1 PL6)	4C13S-03 (3 MB2, 1 PL5)	4C13D-24*Δ (24 MB1)	4C13D-11* (9 MB2, 2 MB3)	4C13S-11*Δ (11 MB1)	4C13S-HOP	4C13S-BIN	4C13S-2P (2 PL6)
# Mailboxes (Total)	6	5	3	24	11	11	0	0	0
# Parcel Lockers (Total)	1	1	1	0	0	0	0	0	2
# Collection	1	1	1	1	1	1	1	0	0
# BINS	0	0	0	0	0	0	0	1	0
# Mailboxes Under 48"	3	2	1	18	7	8	0	0	0
Module Weight (lbs)	68	67	64	133	112	72	69	45	57

NOTES:

See page 12 for mailbox (MB) and parcel locker (PL) compartment size definitions and configurable options. Key to module notations are as follows:

Δ Modules are configurable. Visit florencemailboxes.com/configure to create your custom solution

* Modules do not meet USPS installation specifications and are for private delivery.

φ Modules contain PL under the USPS required 15" tall minimum

+ Modules meet ADA upper reach limit of 48" FFF when installed at recommended height

Modules meet Fair Housing side reach limit of 54" FFF when installed at recommended height

12 DOOR HIGH SUITE

Actual: 44-1/4"H x 31-9/16"W (Double) or 17-1/2"W (Single) x 17"D
Rough Opening: 43-5/16"H x 30-5/16"W (Double) or 16-1/4"W (Single) x 17"D

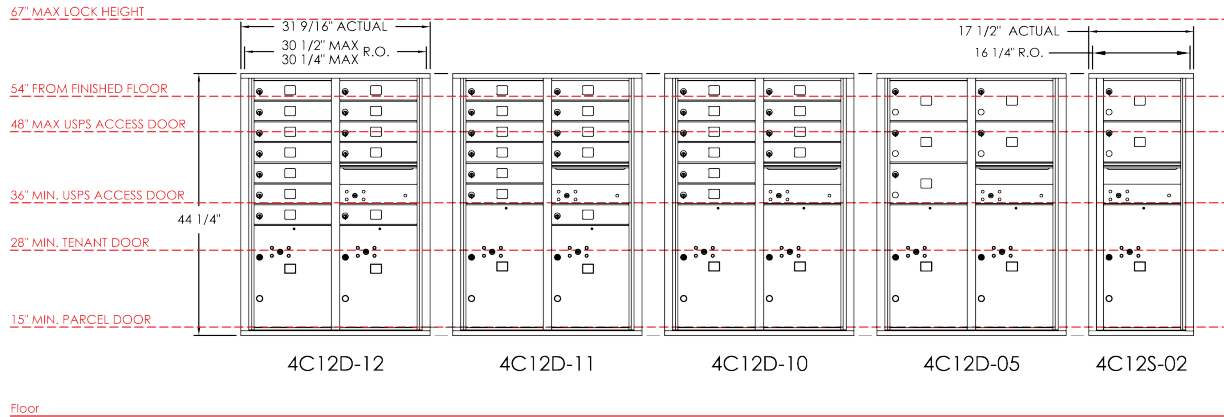

MODEL (COMPARTMENT TYPES)	4C12D-12 (12 MB1, 2 PL5)	4C12D-11 (11 MB1, 1 PL5, 1 PL6)	4C12D-10 (10 MB1, 2 PL6)	4C12D-05 (5 MB2, 2 PL6)	4C12S-02 (2 MB2, 1 PL6)
# Mailboxes (Total)	12	11	10	5	2
# Parcel Lockers (Total)	2	2	2	2	1
# Collection	1	1	1	1	1
# BINS	0	0	0	0	0
# Mailboxes Under 48"	8	7	6	3	1
Module Weight (lbs)	116	114	112	104	59

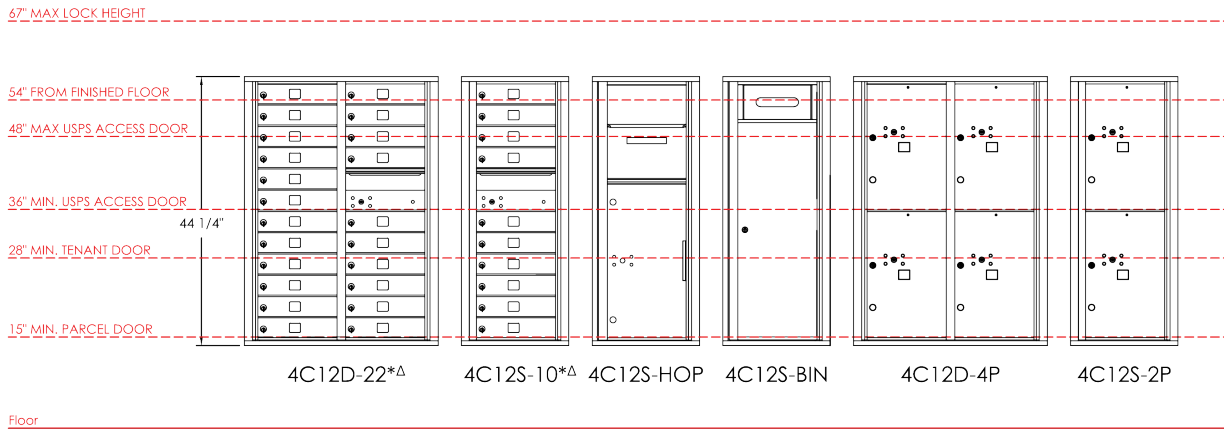

MODEL (COMPARTMENT TYPES)	4C12D-22*Δ (22 MB1)	4C12S-10*Δ (10 MB1)	4C12S-HOP	4C12S-BIN	4C12D-4P (4 PL6)	4C12S-2P (2 PL6)
# Mailboxes (Total)	22	10	0	0	0	0
# Parcel Lockers (Total)	0	0	0	0	4	2
# Collection	1	1	1	0	0	0
# BINS	0	0	0	1	0	0
# Mailboxes Under 48"	18	8	0	0	0	0
Module Weight (lbs)	124	68	66	45	97	53

NOTES:

- See page 12 for mailbox (MB) and parcel locker (PL) compartment size definitions and configurable options. Key to module notations are as follows:
- Δ Modules are configurable. Visit florencemailboxes.com/configure to create your custom solution
- * Modules do not meet USPS installation specifications and are for private delivery.
- φ Modules contain PL under the USPS required 15" tall minimum
- + Modules meet ADA upper reach limit of 48" FFF when installed at recommended height
- # Modules meet Fair Housing side reach limit of 54" FFF when installed at recommended height

11 DOOR HIGH SUITE

Actual: 40-3/4"H x 31-9/16"W (Double) or 17-1/2"W (Single) x 17"D
Rough Opening: 39-13/16"H x 30-5/16"W (Double) or 16-1/4"W (Single) x 17"D

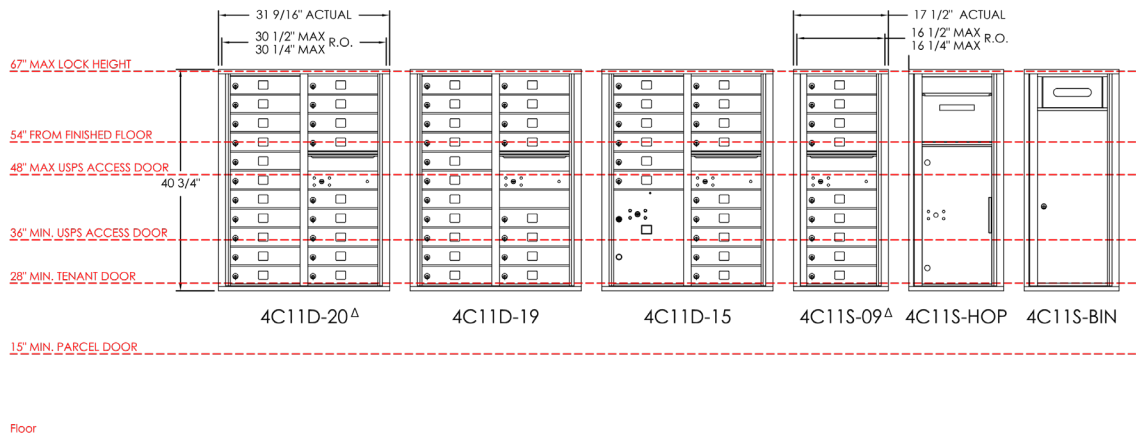

MODEL (COMPARTMENT TYPES)	4C11D-20 ^Δ (20 MB1)	4C11D-19 (19 MB1)	4C11D-15 (15 MB1, 1 PL5)	4C11S-09 ^Δ (9 MB1)	4C11S-HOP	4C11S-BIN
# Mailboxes (Total)	20	19	15	9	0	0
# Parcel Lockers (Total)	0	0	1	0	0	0
# Collection	1	1	1	1	1	0
# BINS	0	0	0	0	0	1
# Mailboxes Under 48"	11	10	6	5	0	0
Module Weight (lbs)	123	122	119	56	65	45

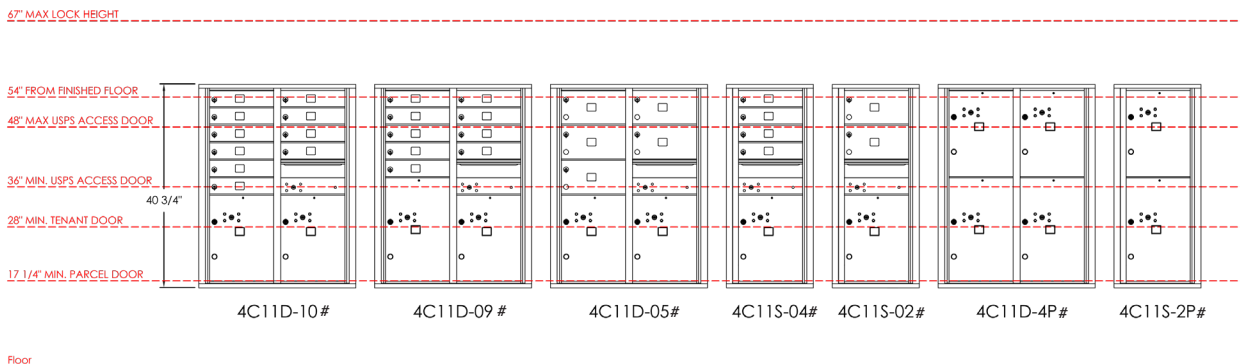

MODEL (COMPARTMENT TYPES)	4C11D-10# (10 MB1, 2 PL5)	4C11D-09# (9 MB1, 1 PL5, 1 PL6)	4C11D-05# (5 MB2, 2 PL5)	4C11S-04# (4 MB1, 1 PL5)	4C11S-02# (2 MB1, 1 PL5)	4C11D-4P# (2 PL5, 2 PL6)	4C11S-2P# (1 PL5, 1 PL6)
# Mailboxes (Total)	10	9	5	4	2	0	0
# Parcel Lockers (Total)	2	2	2	1	1	4	2
# Collection	1	1	1	1	1	0	0
# BINS	0	0	0	0	0	0	0
# Mailboxes Under 48"	1	0	0	0	0	0	0
Module Weight (lbs)	115	113	106	53	50	99	45

NOTES:

See page 12 for mailbox (MB) and parcel locker (PL) compartment size definitions and configurable options. Key to module notations are as follows:

^Δ Modules are configurable. Visit florencemailboxes.com/configure to create your custom solution

* Modules do not meet USPS installation specifications and are for private delivery.

φ Modules contain PL under the USPS required 15" tall minimum

+ Modules meet ADA upper reach limit of 48" FFF when installed at recommended height

Modules meet Fair Housing side reach limit of 54" FFF when installed at recommended height

versatile™
4C mailboxes &
parcel lockers

10 DOOR HIGH SUITE

Actual: 37-1/4"H x 31-9/16"W (Double) or 17-1/2"W (Single) x 17"D
Rough Opening: 36-5/16"H x 30-5/16"W (Double) or 16-1/4"W (Single) x 17"D

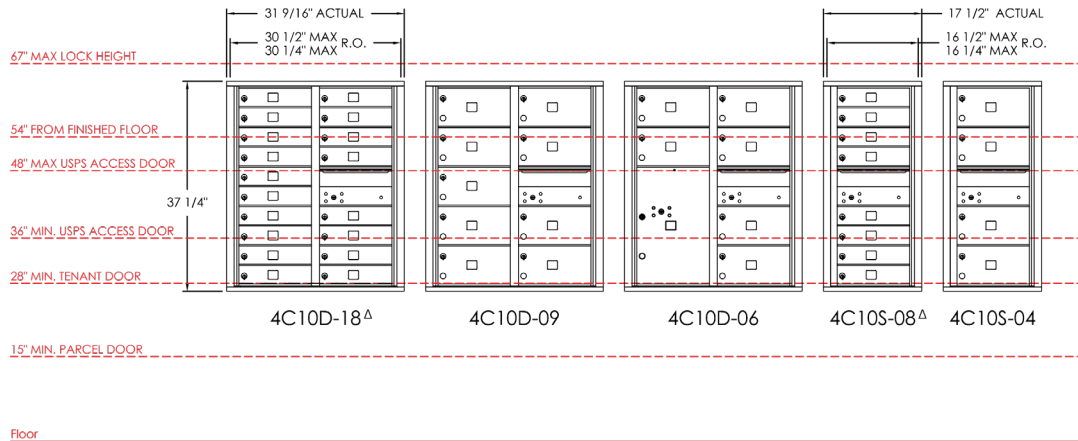



MODEL (COMPARTMENT TYPES)	4C10D-18 Δ (18 MB1)	4C10D-09 (9 MB2)	4C10D-06 (6 MB2, 1 PL6)	4C10S-08 Δ (8 MB1)	4C10S-04 (4 MB2)
# Mailboxes (Total)	18	9	6	8	4
# Parcel Lockers (Total)	0	0	1	0	0
# Collection	1	1	1	1	1
# BINS	0	0	0	0	0
# Mailboxes Under 48"	10	5	2	4	2
Module Weight (lbs)	97	84	83	56	47

Mailbox Configurator

Florence offers an industry unique online Revit mailbox configurator you can use to create your own versatile™ 4C installation.

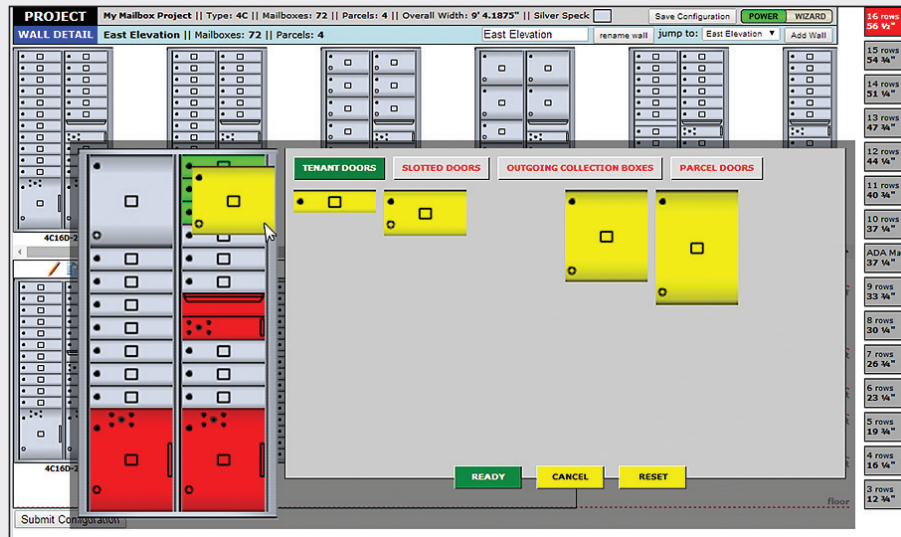
This drag and drop tool will help guide you step-by-step, provide you with BIM and/or CAD drawings of your creation, and give you the ability to submit it for a quote.



 florencemailboxes.com/configure

NOTES:

See page 12 for mailbox (MB) and parcel locker (PL) compartment size definitions and configurable options. Key to module notations are as follows:

- Δ Modules are configurable. Visit florencemailboxes.com/configure to create your custom solution
- * Modules do not meet USPS installation specifications and are for private delivery.
- ◊ Modules contain PL under the USPS required 15" tall minimum
- + Modules meet ADA upper reach limit of 48" FFF when installed at recommended height
- # Modules meet Fair Housing side reach limit of 54" FFF when installed at recommended height

versatile™
4C mailboxes &
parcel lockers

ADA compliant heights

10 DOOR HIGH / ADA MAX SUITE

Actual: 37-1/4"H x 31-9/16"W (Double) or 17-1/2"W (Single) x 17"D
Rough Opening: 36-5/16"H x 30-5/16"W (Double) or 16-1/4"W (Single) x 17"D
Full suite also available in freestanding Depot cabinet

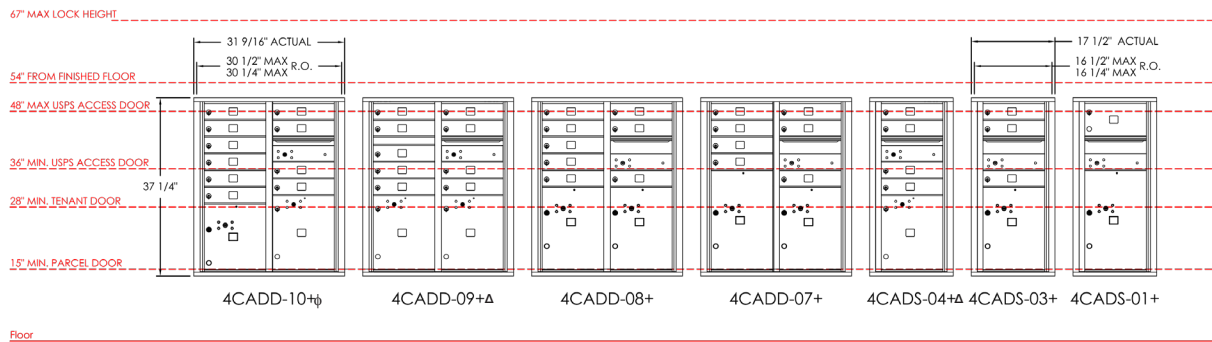

MODEL (COMPARTMENT TYPES)	4CADD-10+ ^φ (10 MB1, 1 PL4, 1 PL15)	4CADD-09+ ^Δ (9 MB1, 2 PL15)	4CADD-08+ (8 MB1, 2 PL5)	4CADD-07+ (7 MB1, 1 PL5, 1 PL6)	4CADS-04+ ^Δ (4 MB1, 1 PL15)	4CADS-03+ (3 MB1, 1 PL5)	4CADS-01+ (1 MB2, 1 PL6)
# Mailboxes (Total)	10	9	8	7	4	3	1
# Parcel Lockers (Total)	2	2	2	2	1	1	1
# Collection	1	1	1	1	1	1	1
# BINS	0	0	0	0	0	0	0
# Mailboxes Under 48"	10	9	8	7	4	3	1
Module Weight (lbs)	91	96	88	89	55	49	46

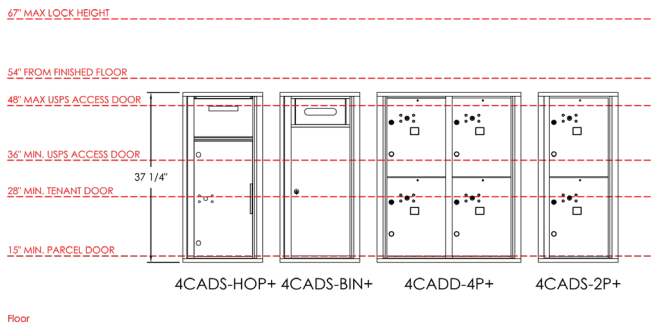

MODEL (COMPARTMENT TYPES)	4CADS-HOP+ (4 MB1, 1 PL5)	4CADS-BIN+ (4 MB1, 1 PL5)	4CADD-4P+ (4 PL5)	4CADS-2P+ (2 PL5)
# Mailboxes (Total)	0	0	0	0
# Parcel Lockers (Total)	0	0	4	2
# Collection	1	0	0	0
# BINS	0	1	0	0
# Mailboxes Under 48"	0	0	0	0
Module Weight (lbs)	41	52	80	43

Designing Compliant Mailrooms

For interior mailrooms, the ADA specifies that at least 5% of the total mailboxes must meet accessibility guidelines with installation heights 15" to 48".

Local regulations may override this percentage and require 100% compliance. Typically, it is the local jurisdiction codes office/inspector that will designate if an installation must meet only the minimum ADA requirement of 5% or if it should be 100% compliant.

See page 32 for additional guidelines.

ADA Standards, Section 228.2



NOTES:

See page 12 for mailbox (MB) and parcel locker (PL) compartment size definitions and configurable options. Key to module notations are as follows:

- Δ Modules are configurable. Visit florencemailboxes.com/configure to create your custom solution
- * Modules do not meet USPS installation specifications and are for private delivery.
- φ Modules contain PL under the USPS required 15" tall minimum
- + Modules meet ADA upper reach limit of 48" FFF when installed at recommended height
- # Modules meet Fair Housing side reach limit of 54" FFF when installed at recommended height

versatile™
4C mailboxes &
parcel lockers

9 DOOR HIGH SUITE

Actual: 33-3/4"H x 31-9/16"W (Double) or 17-1/2"W (Single) x 17"D
Rough Opening: 32-13/16"H x 30-5/16"W (Double) or 16-1/4"W (Single) x 17"D

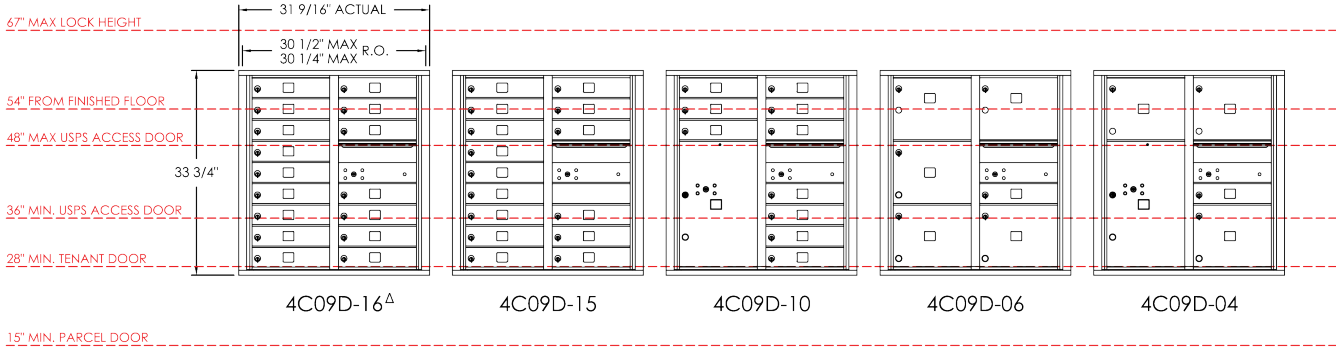

Floor

MODEL (COMPARTMENT TYPES)	4C09D-16 Δ (16 MB1)	4C09D-15 (15 MB1)	4C09D-10 (10 MB1, 1 PL6)	4C09D-06 (1 MB1, 5 MB3)	4C09D-04 (1 MB1, 3 MB3, 1 PL6)
# Mailboxes (Total)	16	15	10	6	4
# Parcel Lockers (Total)	0	0	1	0	1
# Collection	1	1	1	1	1
# BINS	0	0	0	0	0
# Mailboxes Under 48"	10	9	4	4	2
Module Weight (lbs)	89	88	84	75	76

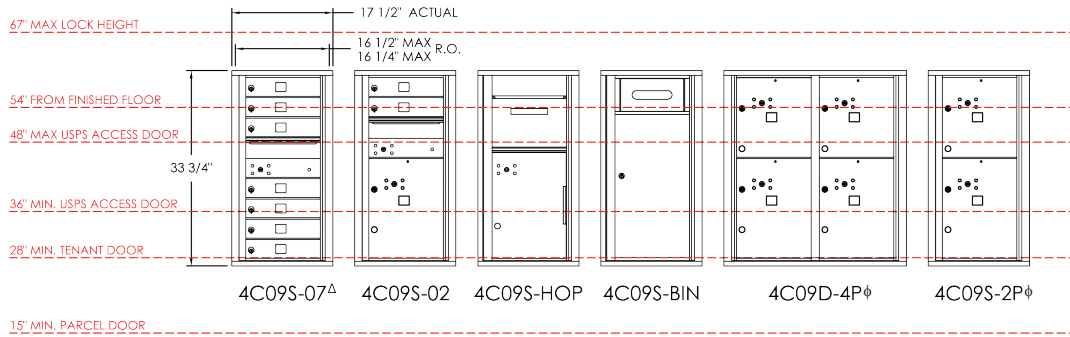

Floor

MODEL (COMPARTMENT TYPES)	4C09S-07 Δ (7 MB1)	4C09S-02 (2 MB1, 1 PL5)	4C09S-HOP	4C09S-BIN	4C09D-4Pφ (2 PL4, 2 PL5)	4C09S-2Pφ (1 PL4, 1 PL5)
# Mailboxes (Total)	7	2	0	0	0	0
# Parcel Lockers (Total)	0	1	0	0	4	2
# Collection	1	1	1	0	0	0
# BINS	0	0	0	1	0	0
# Mailboxes Under 48"	4	0	0	0	0	0
Module Weight (lbs)	48	45	52	41	76	40

NOTES:

- See page 12 for mailbox (MB) and parcel locker (PL) compartment size definitions and configurable options. Key to module notations are as follows:
- Δ Modules are configurable. Visit florencemailboxes.com/configure to create your custom solution
- * Modules do not meet USPS installation specifications and are for private delivery.
- φ Modules contain PL under the USPS required 15" tall minimum
- + Modules meet ADA upper reach limit of 48" FFF when installed at recommended height
- # Modules meet Fair Housing side reach limit of 54" FFF when installed at recommended height

8 DOOR HIGH SUITE

Actual: 30-1/4"H x 31-9/16"W (Double) or 17-1/2"W (Single) x 17"D

Rough Opening: 29-5/16"H x 30-5/16"W (Double) or 16-1/4"W (Single) x 17"D

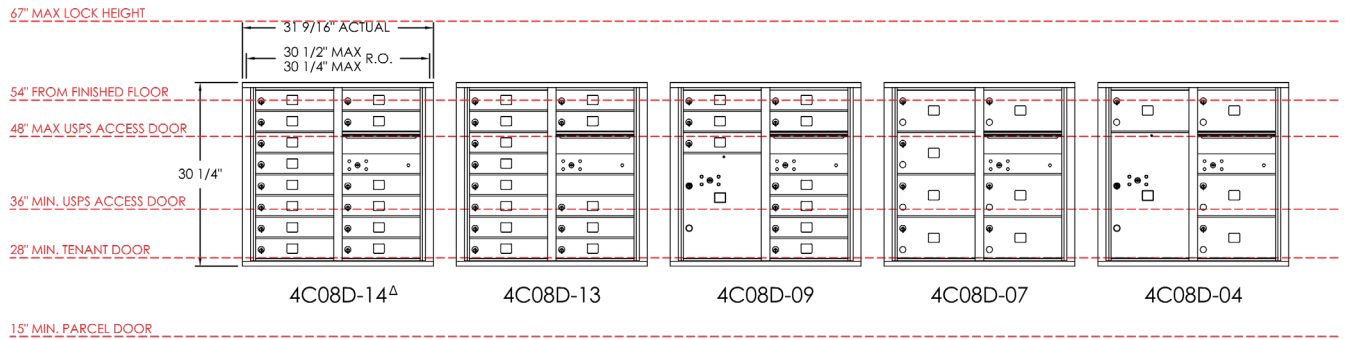

Floor

MODEL (COMPARTMENT TYPES)	4C08D-14 Δ (14 MB1)	4C08D-13 (13 MB1)	4C08D-09 (9 MB1, 1 PL5)	4C08D-07 (7 MB2)	4C08D-04 (4 MB2, 1 PL6)
# Mailboxes (Total)	14	13	9	7	4
# Parcel Lockers (Total)	0	0	1	0	1
# Collection	1	1	1	1	1
# BINS	0	0	0	0	0
# Mailboxes Under 48"	10	9	5	5	2
Module Weight (lbs)	81	80	78	72	71

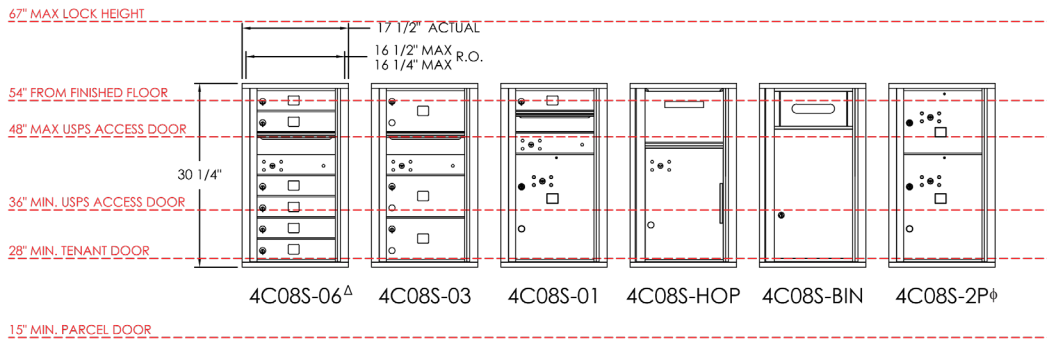

Floor

MODEL (COMPARTMENT TYPES)	4C08S-06 Δ (6 MB1)	4C08S-03 (3 MB2)	4C08S-01 (1 MB1, 1 PL5)	4C08S-HOP	4C08S-BIN	4C08S-2Pφ (1 PL3, 1 PL5)
# Mailboxes (Total)	6	3	1	0	0	0
# Parcel Lockers (Total)	0	0	1	0	0	2
# Collection	1	1	1	1	0	0
# BINS	0	0	0	0	1	0
# Mailboxes Under 48"	4	2	0	0	0	0
Module Weight (lbs)	44	40	40	52	44	37

NOTES:

See page 12 for mailbox (MB) and parcel locker (PL) compartment size definitions and configurable options. Key to module notations are as follows:

Δ Modules are configurable. Visit florencemailboxes.com/configure to create your custom solution

* Modules do not meet USPS installation specifications and are for private delivery.

φ Modules contain PL under the USPS required 15" tall minimum

+ Modules meet ADA upper reach limit of 48" FFF when installed at recommended height

Modules meet Fair Housing side reach limit of 54" FFF when installed at recommended height

versatile™
4C mailboxes &
parcel lockers

7 DOOR HIGH SUITE

Actual: 26-3/4"H x 31-9/16"W (Double) or 17-1/2"W (Single) x 17"D
Rough Opening: 25-13/16"H x 30-5/16"W (Double) or 16-1/4"W

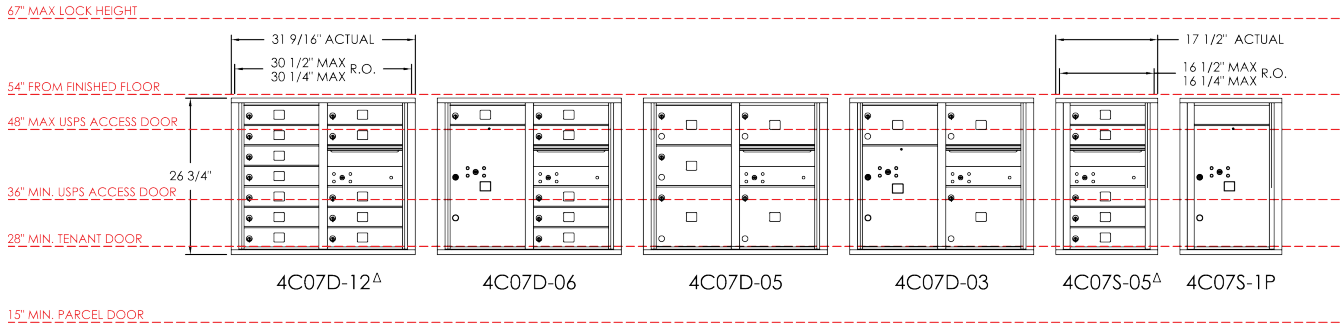

Floor

MODEL (COMPARTMENT TYPES)	4C07D-12 Δ (12 MB1)	4C07D-06 (6 MB1, 1 PL6)	4C07D-05 (3 MB2, 2 MB3)	4C07D-03 (2 MB2, 1 MB3, 1 PL5)	4C07S-05 Δ (5 MB1)	4C07S-1P (1 PL6)
# Mailboxes (Total)	12	6	5	3	5	0
# Parcel Lockers (Total)	0	1	0	1	0	1
# Collection	1	1	1	1	1	0
# BINS	0	0	0	0	0	0
# Mailboxes Under 48"	10	4	3	1	4	0
Module Weight (lbs)	73	68	64	65	40	32

NOTES:

See page 12 for mailbox (MB) and parcel locker (PL) compartment size definitions and configurable options. Key to module notations are as follows:

Δ Modules are configurable. Visit florencemailboxes.com/configure to create your custom solution

* Modules do not meet USPS installation specifications and are for private delivery.

⊕ Modules contain PL under the USPS required 15" tall minimum

+ Modules meet ADA upper reach limit of 48" FFF when installed at recommended height

Modules meet Fair Housing side reach limit of 54" FFF when installed at recommended height



6 DOOR HIGH SUITE

Actual: 23-1/4"H x 31-9/16"W (Double) or 17-1/2"W (Single) x 17"D

Rough Opening: 22-5/16"H x 30-5/16"W (Double) or 16-1/4"W (Single) x 17"D

Full suite also available in freestanding Depot cabinet

67" MAX LOCK HEIGHT

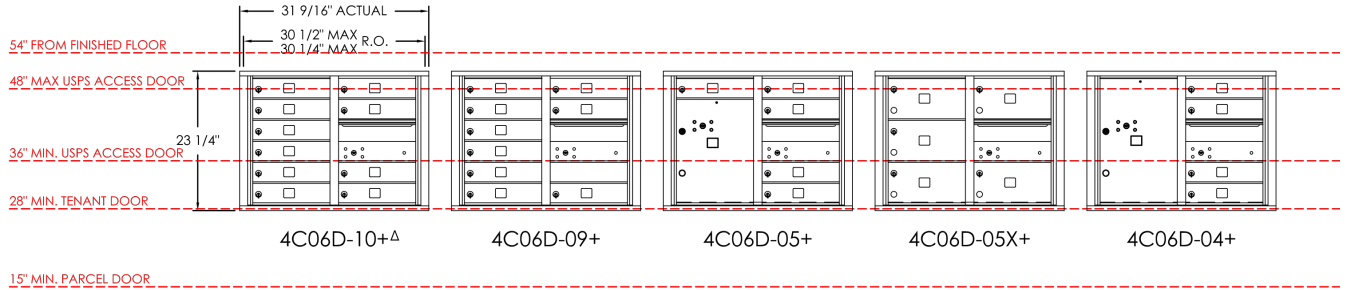

Floor

MODEL (COMPARTMENT TYPES)	4C06D-10+Δ (10 MB1)	4C06D-09+ (9 MB1)	4C06D-05+ (5 MB1, 1 PL5)	4C06D-05X+ (5 MB2)	4C06D-04+ (4 MB1, 1 PL6)
# Mailboxes (Total)	10	9	5	5	4
# Parcel Lockers (Total)	0	0	1	0	1
# Collection	1	1	1	1	1
# Mailboxes Under 48"	10	9	5	5	4
Module Weight (lbs)	66	65	59	62	61

67" MAX LOCK HEIGHT

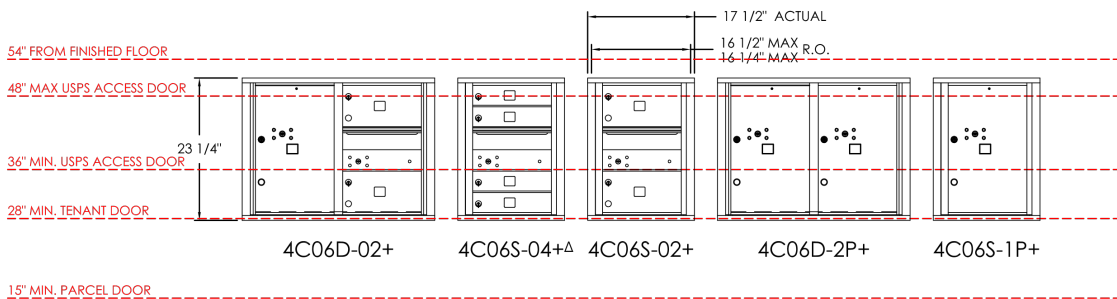

Floor

MODEL (COMPARTMENT TYPES)	4C06D-02+ (2 MB2, 1 PL6)	4C06S-04+Δ (4 MB1)	4C06S-02+ (2 MB2)	4C06D-2P+ (2 PL6)	4C06S-1P+ (1 PL6)
# Mailboxes (Total)	2	4	2	0	0
# Parcel Lockers (Total)	1	0	0	2	1
# Collection	1	1	1	0	0
# Mailboxes Under 48"	2	4	2	0	0
Module Weight (lbs)	58	36	33	53	28

NOTES:

See page 12 for mailbox (MB) and parcel locker (PL) compartment size definitions and configurable options. Key to module notations are as follows:

Δ Modules are configurable. Visit florencemailboxes.com/configure to create your custom solution

* Modules do not meet USPS installation specifications and are for private delivery.

φ Modules contain PL under the USPS required 15" tall minimum

+ Modules meet ADA upper reach limit of 48" FFF when installed at recommended height

Modules meet Fair Housing side reach limit of 54" FFF when installed at recommended height

Installation and Accessibility References

Designing appropriate accessibility into every feature of a facility is a key consideration for any project, and how the mailboxes are installed into that facility is no exception. Plus, all wall-mounted mailboxes which will be serviced by the U.S. Postal Service (USPS) must also be installed according to specifications as outlined in the USPS STD-4C regulation.

To assist you with selecting mailboxes that meet the specific requirements of your project, details related to installed heights are noted on the Florence versatile™ 4C mailbox modules references on pages 20-31. Below are also the quick references related to accessible uses and USPS requirements to help you in determining your project layout and design.

MEETING USPS INSTALLATION REQUIREMENTS

Florence Corporation USPS Approved 4C mailbox products are designed to adhere to STD-4C regulations. To ensure your project complies with USPS regulations for wall-mounted mailboxes, your mailbox center must be installed according to the following U.S. Postal Service guidelines:

Installation requirements specified in the U.S. Postal Service STD-4C regulation are outlined below:

1. At least one customer compartment shall be positioned less than 48 inches above the finished floor.
2. No parcel locker compartment (interior bottom shelf) shall be positioned less than 15 inches above the finished floor.
3. No customer lock shall be located more than 67 inches above the finished floor.
4. No customer compartment (interior bottom shelf) shall be positioned less than 28 inches above the finished floor.
5. The USPS Arrow lock shall be located between 36 and 48 inches above the finished floor.

Standards Governing the Design of Wall-Mounted Centralized Mail Receptacles. Federal Register/Vol. 69, No 171/September 3, 2004

Rules and Regulations POSTAL SERVICE, 39 CFR Part 111. www.gpo.gov/fdsys/pkg/FR-2004-09-03/pdf/04-19781.pdf

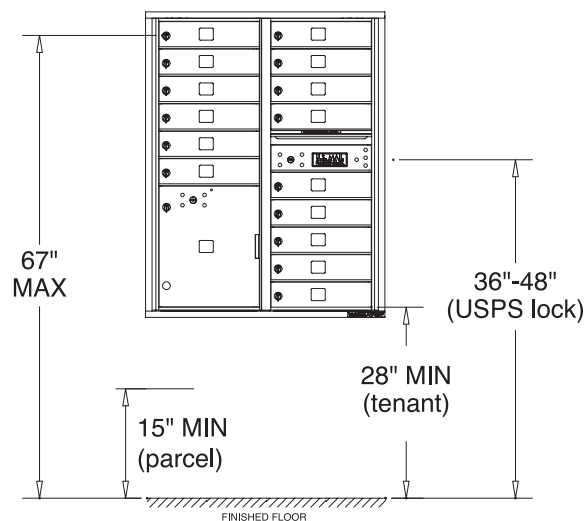

MEETING ADA INSTALLATION REQUIREMENTS

Accessibility regulations may vary by type of facility and by governing jurisdictions. Therefore, always consult local building officials and codes for applicable accessibility requirements that could affect your mailbox project. Below are industry references for your convenience.

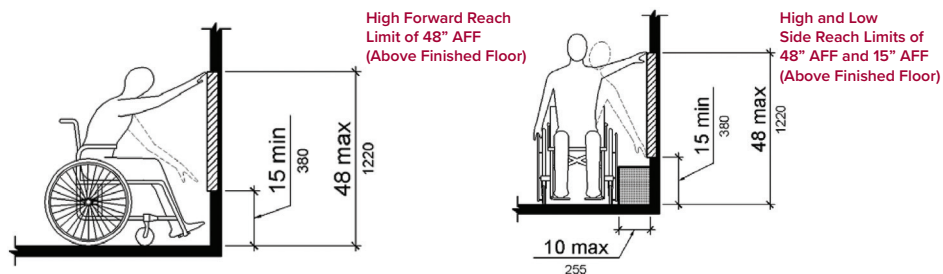

2010 ADA Standards for Accessible Design, Department of Justice Code of Federal Regulations, ADA CHAPTER 2: SCOPING REQUIREMENTS, 228.2 Mail Boxes: Where mail boxes are provided in an interior location, at least 5 percent, but no fewer than one, of each type shall comply with 309. In residential facilities, where mail boxes are provided for each residential dwelling unit, mail boxes complying with 309 shall be provided for each residential dwelling unit required to provide mobility features complying with 809.2 through 809.4.

The full text can be found at: www.ada.gov/2010ADASTandards_index.htm



120RA

120 Series Collection Box

 florencemailboxes.com/collection-box

Indoor letter collection boxes secure mail until pick up by the USPS.

STANDARD FEATURES

- Front-load, Recessed-mounted
- Prepared for USPS installed master lock
- Anodized aluminum powder coat finish
- Engraved "LETTERS"
- Frame Size: 19-1/8"H x 15-1/6" W
- Rough Opening Size: 17-5/8" H x 13-5/8" W x 6 -3/4" D

OPTIONAL FEATURES

- Private master lock available
- Surface-mount collar
- Designated custom engraving
- Letter slot size: 3/4"H x 10"W

MODEL	DESCRIPTION
120RA	Fully-recessed collection box is a standard aluminum unit with engraved "LETTERS" prepared for USPS lock.
120SPR	Recessed collection box. Private lock. Specify engraving.
120SMSA	Surface-mounted collection box is a standard aluminum unit with engraved "LETTERS" prepared for USPS lock.
120SPSMS	Surface-mounted collection box. Private lock. Specify engraving.

Key Keepers

Key Keepers are prepared to accept a postal lock installed by local postal officials, providing secure access to important keys.

STANDARD FEATURES

- Recessed- or surface-mounted
- Prepared for USPS installed master lock
- Anodized aluminum
- Extruded aluminum construction
- Exterior dims: 6-3/4" H x 6-1/4" W x 2-3/8" D
- Interior dims: 4-5/8" H x 4-1/16" W x 2" D
- Rough opening: 5-1/8" H x 4-3/8" W x 2-1/4" D

 florencemailboxes.com/keykeepers



Model KK



Model KKSM

MODEL	DESCRIPTION
KK	Recess-mounted key keeper. Prepared for USPS lock.
KKASMA	Surface-mounted key keeper. Prepared for USPS lock.

Directories

These surface-mounted directories can be used independently or installed next to any mailbox installation to neatly and alphabetically list the names of your residents. A clear plastic window, metal back plate, and blank ruled name cards are included with each directory.

STANDARD FEATURES

- Anodized aluminum or powder coat finish (color options below)
- Extruded aluminum construction
- 40 name capacity
- D400-1: 19" H x 8-3/4" W



D400-1A



 florencemailboxes.com/directories

COLOR OPTIONS

Select either Anodized Aluminum or one of eight different architectural powder coat finishes as noted for all mailbox accessories.

<p>Antique Bronze (AB) PMS 8622C</p>	<p>Black (BK) PMS Black 6C</p>
<p>Dark Bronze (DB) PMS Black 7C</p>	<p>Gold Speck (GS) PMS 7-5C</p>
<p>Postal Grey (PG) PMS 413C</p>	<p>Sandstone (SD) PMS 7501C</p>
<p>Silver Speck (SS) PMS 877C</p>	<p>White (WH) PMS White</p>

Colors shown are representative of the actual powder coat finish but are limited by printing conditions and may vary slightly from finished product.

Replacement Mailboxes

HORIZONTAL AND VERTICAL WALL-MOUNTED UNITS



For Postal Delivery
**1400 Series
STD-4B+
Horizontals**

**1250 Series
STD-4B+
Verticals**

For Private Delivery
**1600/1700
Series
Horizontals**

Always check with local U.S. Postal Service officials before proceeding with mailbox replacement projects.



Horizontal Recess Mounted



Vertical Recessed or Surface Mounted

MAILBOX REPLACEMENT GUIDELINES

You may replace your mailboxes with similar products on a **1:1** basis if your renovation does not affect your rough opening.

USPS STD-4C compliant mailboxes are required for major renovation projects. Refer to pages 10-33.



1:5 PARCEL LOCKER TO CUSTOMER COMPARTMENT RATIO REQUIRED BY USPS

Download the "Repair or Replace" guide from our Property Manager Toolkit on www.florencemailboxes.com/property-manager-toolkit



1400 Series Horizontals (STD 4B+)

FEATURES & OPTIONS

As an indoor solution, these traditional-style mailboxes are most popular in apartment complexes, and university/military housing. The standard for decades, these are available as replacement units for worn out installations. (All new construction must use postal approved STD-4C mailboxes.)

STANDARD FEATURES

- Front-load
- Recess-mounted
- Prepared for USPS installed Master Lock
- Anodized aluminum finish
- 5-pin cylinder tenant cam lock with two keys (1,000 key changes)
- Snap-on outer trim kit (available by request)
- Clear plastic number slots or engraved numbers



florencemailboxes.com/horizontal

OPTIONAL FEATURES

- Private master lock
- Configurable door sizes and layout options

Note: Horizontal mailbox installations should be protected from direct exposure to the weather; Florence is not responsible for damage caused by weather conditions as these products are rated for indoor use only.



Plastic Number Slot: Number slots are 5/8" H x 2" W. (Available on tenant compartment doors only.)

Engraving: Custom engraving utilizes the USPS Standard US Block font and is 3/4" tall. All engraving can include up to 5 characters in one line per door.

MAIL, OUTGOING MAIL & PARCEL LOCKER COMPARTMENT SIZES



1400
(5" H x 6-3/8" W)



1403
(5" H x 12-7/8" W)



1404
(10-3/8" H x 12-7/8" W)

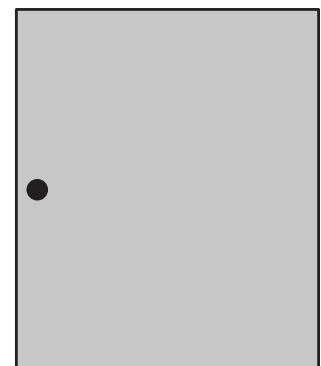

1406
(15-3/4" H x 12-7/8" W)

All door sizes suitable for incoming mail.
All door sizes suitable for outgoing mail slot with or without a lock.
Door sizes 1404 & 1406 suitable for parcel lockers.

5 DOORS HIGH

Actual: 28" H / Rough Opening: 28-1/4" H

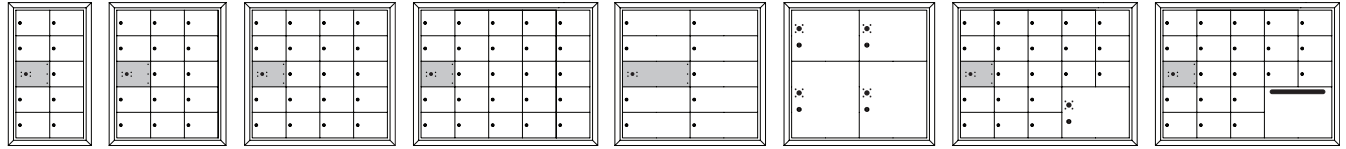

MODEL	140052A*	140053A*	140054A*	140055A*	140054DA	140054PLA	140055PLA	140055OUA
# Mailboxes (Total)	9	14	19	24	9	0	20	20
# Parcel Lockers (Total)	0	0	0	0	0	4	1	0
# Collection	0	0	0	0	0	0	0	1
Actual Width	14-3/8"	20-3/4"	27-1/4"	33-5/8"	27-1/4"	27-1/4"	33-5/8"	33-5/8"
Rough Opening	14-5/8"	21"	27-1/2"	33-7/8"	27-1/2"	27-1/2"	33-7/8"	33-7/8"

6 DOORS HIGH

Actual: 33-3/8" H / Rough Opening: 33-5/8" H

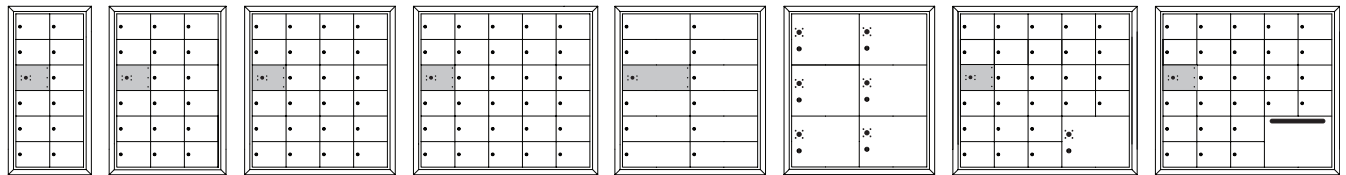

MODEL	140062A*	140063A*	140064A*	140065A*	140064DA	140064PLA	140065PLA	140065OUA
# Mailboxes (Total)	11	17	23	29	11	0	25	25
# Parcel Lockers (Total)	0	0	0	0	0	6	1	0
# Collection	0	0	0	0	0	0	0	1
Actual Width	14-3/8"	20-3/4"	27-1/4"	33-5/8"	27-1/4"	27-1/4"	33-5/8"	33-5/8"
Rough Opening	14-5/8"	21"	27-1/2"	33-7/8"	27-1/2"	27-1/2"	33-7/8"	33-7/8"

7 DOORS HIGH

Actual: 38-3/4" H / Rough Opening: 39" H

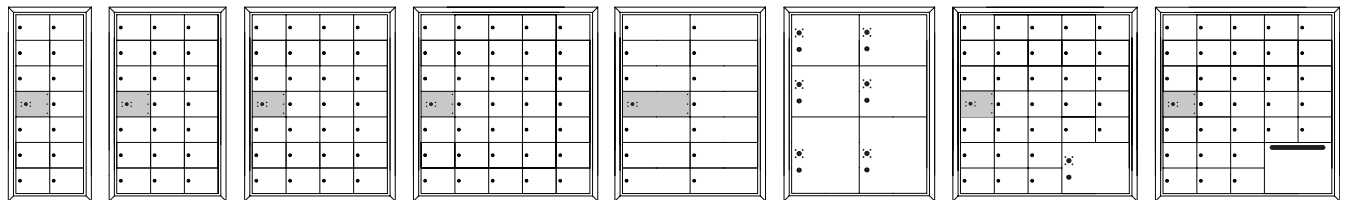

MODEL	140072A*	140073A*	140074A*	140075A*	140074DA	140074PLA	140075PLA	140075OUA
# Mailboxes (Total)	13	20	27	34	13	0	30	30
# Parcel Lockers (Total)	0	0	0	0	0	6	1	0
# Collection	0	0	0	0	0	0	0	1
Actual Width	14-3/8"	20-3/4"	27-1/4"	33-5/8"	27-1/4"	27-1/4"	33-5/8"	33-5/8"
Rough Opening	14-5/8"	21"	27-1/2"	33-7/8"	27-1/2"	27-1/2"	33-7/8"	33-7/8"

NOTES:

Standard modules noted with an asterisk (*) are fully configurable; visit florencemailboxes.com/configure to quickly and easily create your custom solution.

See page 36 for compartment size definitions and configurable options.

All model numbers listed are for standard front-load modules; add -SP for custom modules at the end of the number.

1600/1700 Series Horizontals

FOR PRIVATE DELIVERY



A favorite of University housing managers, this indoor solution helps keep your mail area organized. Available in front-loading (1600 series) or rear-loading (1700 series) units, each module provides a lot of compartments in a small space. Since these are private delivery mailboxes, they are not constrained by postal installation regulations and therefore have no minimum or maximum mounting height requirements.

STANDARD FEATURES

- Private master lock
- Recessed mounted
- Anodized aluminum finish
- 5-pin cylinder tenant cam lock with two keys (1,000 key changes)
- Snap-on outer trim kit (available by request)
- Clear plastic number slots or engraved numbers

OPTIONAL FEATURES

- Hinged rear doors with private lock (for 1700)
- Configurable door sizes and layout options

Note: Horizontal mailbox installations should be protected from direct exposure to the weather; Florence is not responsible for damage caused by weather conditions as these products are rated for indoor use only.



florencemailboxes.com/configure

Rear-load mailboxes (1700 series) have an exposed back for easy distribution, so keep in mind during planning that additional space will be necessary for a secure room behind the installation. Access to the room may be restricted and easily accessed using a key keeper (see page 33).



MAIL, OUTGOING MAIL & PARCEL LOCKER COMPARTMENT SIZES

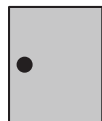

1601/1701
(5" H x 4" W)



1603/1703
(5" H x 8-1/16" W)



1605/1705
(5" H x 12-1/8" W)

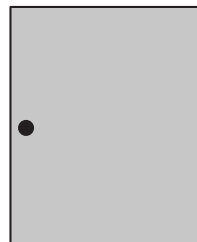

1604/1704
(10-3/8" H x 8-1/16" W)

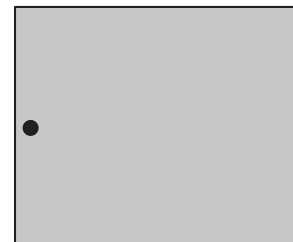

1607/1707
(10-3/8" H x 12-1/8" W)

All door sizes suitable for incoming mail.
All door sizes suitable for outgoing mail slot with or without a lock.
Door sizes 1604/1704 & 1607/1707 suitable for parcel lockers.

1600/1700 Series Horizontals Preconfigured Modules



7 DOORS HIGH

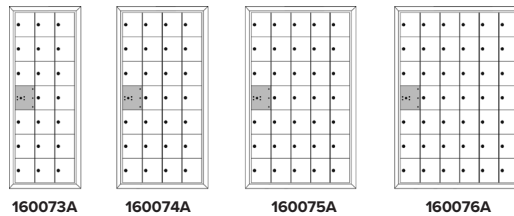

Actual: 38-3/4" H
Rough Opening: 39" H

MODEL	160073A	160074A	160075A	160076A
# Mailboxes (Total)	20	27	34	41
Actual Width	13-3/4"	17-13/16"	21-7/8"	25-15/16"
Rough Opening	14"	18-1/16"	22-1/8"	26-3/16"

8 DOORS HIGH

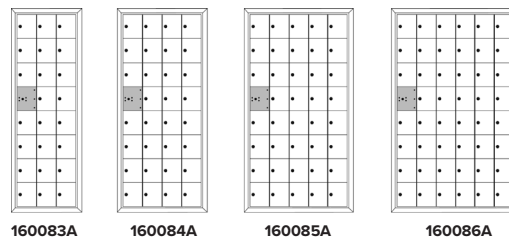

Actual: 44-3/16" H
Rough Opening: 44-7/16" H

MODEL	160083A	160084A	160085A	160086A
# Mailboxes (Total)	23	31	39	47
Actual Width	13-3/4"	17-13/16"	21-7/8"	25-15/16"
Rough Opening	14"	18-1/16"	22-1/8"	26-3/16"

9 DOORS HIGH

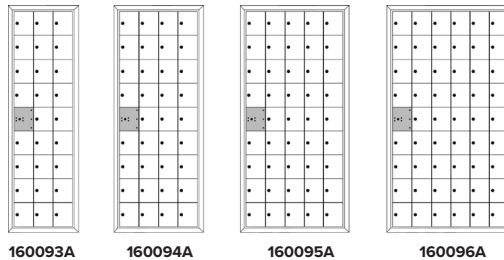

Actual: 49-9/16" H
Rough Opening: 49-13/16" H

MODEL	160093A	160094A	160095A	160096A
# Mailboxes (Total)	26	35	44	53
Actual Width	13-3/4"	17-13/16"	21-7/8"	25-15/16"
Rough Opening	14"	18-1/16"	22-1/8"	26-3/16"

10 DOORS HIGH

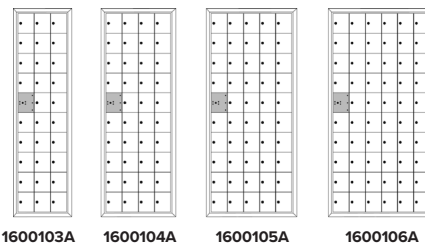

Actual: 55" H
Rough Opening: 55-1/4" H

MODEL	1600103A	1600104A	1600105A	1600106A
# Mailboxes (Total)	29	39	49	59
Actual Width	13-3/4"	17-13/16"	21-7/8"	25-15/16"
Rough Opening	14"	18-1/16"	22-1/8"	26-3/16"

NOTES:

All modules are fully configurable; visit florencemailboxes.com/configure to quickly and easily create your custom solution.

See page 36 for compartment size definitions and configurable options.

All model numbers listed are for standard front-load modules; add -SP for custom modules at the end of the number.

1250 Vertical Mailboxes



PRODUCT FEATURES

Vertical mailboxes have been a staple for mail delivery in small apartment communities for decades. Vertical mailboxes can be used for Postal Delivery only when they replace older vertical mailboxes for one-to-one replacement purposes. Over the years, postal regulations have changed and these mailboxes are no longer approved for new construction. These units are top-loading and should be protected from the weather.

STANDARD FEATURES

- Top-load/front-load
- Recessed- or surface-mounted
- Prepared for USPS installed Master Lock
- Mailbox material: Anodized aluminum
- Surface collar material: Silver powder coated steel
- 5-pin cylinder cam locks with two keys (1,000 key changes)
- Name and number ID card holders



florencemailboxes.com/vertical

LOCK DETAIL

The 1250 vertical series comes standard with a K30809 lock.



K30809

DOOR SIZE

The 1250 vertical series mailbox is pre-configured with one door size.

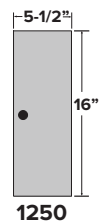

1250

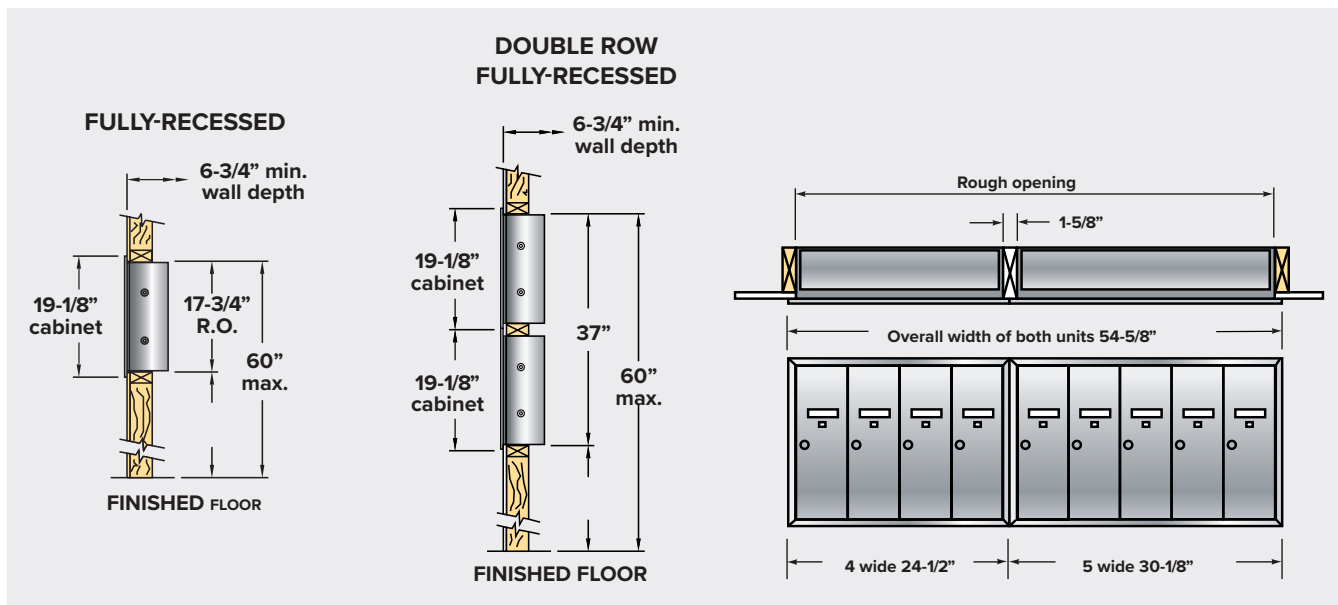

Replacement Mailboxes

1250 Vertical Mailboxes



1250-3HA



1250-4HA



1250-5HA



1250-6HA



1250-7HA

VERTICAL MAILBOX ALL CABINETS: 19-1/8" H 6-1/8" D

Single Row	Double Row	Layout Per Row	Wall Cut Width	Overall Width
3	6	3	17-1/2"	19"
4	8	4	23"	24-1/2"
5	10	5	28-5/8"	30-1/8"
6	12	6	34-1/8"	35-5/8"
7	14	7	39-5/8"	41-1/8"
8	16	4-4	47-1/2"	49"
9	18	5-4	53-1/8"	54-5/8"
10	20	5-5	58-3/4"	60-1/4"
11	22	6-5	64-1/4"	65-3/4"
12	24	6-6	69-3/4"	71-1/4"
13	26	7-6	75-1/4"	76-3/4"
14	28	7-7	80-3/4"	82-1/4"
15	30	5-5-5	88-7/8"	90-3/8"
16	32	5-6-5	94-3/8"	95-7/8"
17	34	6-6-5	99-7/8"	101-3/8"
18	36	6-6-6	105-3/8"	106-7/8"
19	38	6-6-7	110-7/8"	112-3/8"
20	40	7-7-6	116-3/8"	117-7/8"
21	42	7-7-7	121-7/8"	123-3/8"
22	44	6-6-6-4	129-7/8"	131-3/8"
23	46	6-6-6-5	135-1/2"	137"
24	48	6-6-6-6	141"	142-1/2"
25	50	7-6-6-6	146-1/2"	148"
26	52	7-7-7-5	152"	153-1/2"
27	54	7-7-7-6	157-1/2"	159"
28	56	7-7-7-7	163"	164-1/2"
29	58	6-6-6-6-5	171-1/8"	172-5/8"
30	60	6-6-6-6-6	176-5/8"	178-1/8"

Single Row

Wall Cut Depth = 6-3/4"
Wall Cut Height = 17-3/4"
Overall Height = 19-1/8"

Double Row

Wall Cut Depth = 6-3/4"
Wall Cut Height = 37"
Overall Height = 38-1/4"

Note: Vertical mailbox installations should always be protected from direct exposure to the weather. Florence Corporation is not responsible for damage caused by weather conditions.

Surface-Mount Collar

When your mailbox installation location has limited wall depth or walls that are covered in material which makes it difficult to cut a rough opening, the 1250 vertical series has a surface-mount collar option. This collar provides a sleek, finished look for the mailbox.

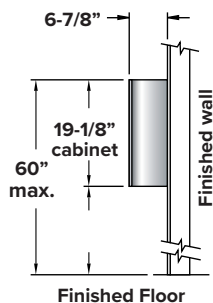

VERTICAL MAILBOX MODEL NUMBERS

NUMBER OF COMPARTMENTS	SURFACE MOUNT MODEL NUMBER
3	12503SMSHA
4	12504SMSHA
5	12505SMSHA
6	12506SMSHA
7	12507SMSHA





Centralized Mail Delivery Equipment Options

Centralized mail delivery provides delivery and collection services to a number of residences from a centrally located installation – whether in a single-family or multi-family community.

The U.S. Postal Service specifies centralized mail delivery in nearly all new construction, single-family or multi-family, because it is the most efficient method of providing the best service, which helps keep the cost of mail service affordable.

Centralized mail delivery equipment can be in the form of any “clustered” style of mailboxes including free-standing, pedestal mounted Cluster Box Units (CBU), or other Standard 4C (STD-4C) compliant mailboxes mounted in or on a wall.

It is vital that subdivision regulations and other community planning guidelines address the need to review and include common space planning for centralized mail delivery equipment.

Check with local postal officials prior to planning any mailbox installation to ensure local requirements and proper placement is included in the overall design plan.

Find a complete list of USPS Approved manufacturers, a local Post Office®, and the proper postal official nearest you at USPS.com or email Delivery.Growth@USPS.gov.

USPS National Delivery Planning Guide for Builders and Developers

To review USPS planning guidelines that apply to your specific project, download the guide from USPS Growth Management at www.USPS.com and click on About USPS/What We are Doing/Current Initiatives/Growth Management.

Ensuring adequate space and convenient locations for your customer’s mail service by planning early for mail delivery in your new development is simply good planning. When you have questions, the Florence team is here to assist every step of the way.

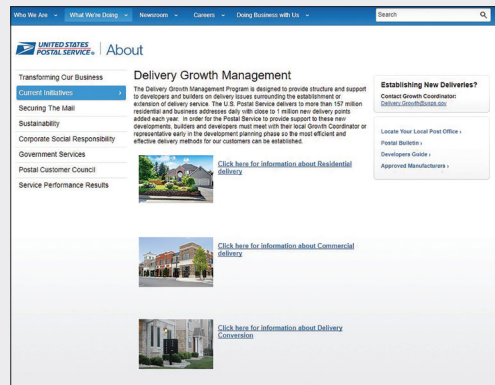

Design and Service Support

ONLINE RESOURCES, DESIGN ASSISTANCE & MORE!

Our toolkits for industry professionals are pre-loaded to ease your project planning. Select from do-it-yourself online tools or contact us for personalized assistance.

 florencemailboxes.com/toolkits

Architect Toolkit

Florence has been included in master specs for decades and is pleased to be specified in over 80% of all projects needing Section 10 55 00 postal specialties in the United States. Whether you need continuing education credits, assistance in navigating current postal regulations, product specific CAD drawings or BIM objects, or written specifications; Florence is here when you need us!

Builder/Developer Toolkit

Whether you need something onsite immediately or are planning for your next project, we've gathered basic resources to help you along the way.

Quickly and easily translate a centralized mailbox installation from an architectural spec for bid, source in stock cluster box units, or learn how mandatory postal regulations and centralized mail delivery may affect your project.

USPS Toolkit

This specialized toolkit is designed to provide our USPS customers with quick access to Florence product-related information needed for internal uses as well as for USPS customers that may be requesting advice about their own mailbox installations.

Property Manager Toolkit

Simplified resources to replace or upgrade existing mailboxes, find parts, manage keys or add accessories like a recycling center for resident convenience.

Superior Architectural Resources

 florencemailboxes.com/architects-toolkit

Florence Corporation has been included in master specs for decades and is pleased to be specified in over 80% of all projects requiring Section 10 55 00 Postal Specialties. Florence has a long-standing tradition of providing architects with the tools they need to complete the job right the first time.

- If utilizing Revit, our BIM objects can easily be pulled into your projects through the Library without leaving the program; or, they can quickly be downloaded directly from the Florence website.
- A short 'how-to' video is also available to guide you through customizing your Florence BIM mailbox objects so they fit your exact project needs.
- Written specifications are available from the website in both .doc and .rtf format.

Florence Product Configurator

The online Florence Product Configurator helps you design the perfect mailbox layout to meet your project specifications. Whether you are building a new mail center or replacing existing mailboxes, we've provided the options to fit your needs.

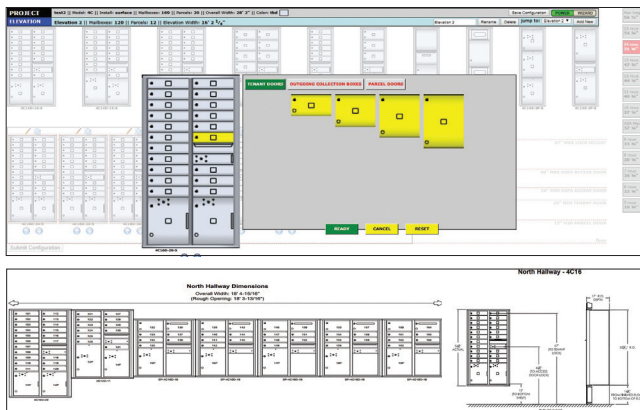

Architect Continuing Education

 florencemailboxes.com/continuing-education

We offer both in-person lunch-and-learns and online courses so you can choose your preferred method of learning about best practices that will make centralized mailbox and package delivery specification easy. Visit our Architect Toolkit to access our AIA accredited course or to contact us to arrange an in-person learning session with your team.



 florencemailboxes.com/configure

Choose your product line, use our drag-and-drop system to design your layout, and then set your numbering schedule.

The Configurator can help select mailbox solutions based on a few simple questions while in Wizard Mode, or allow you to build a completely custom solution that fits your individual project needs while in Power Mode. There is even a Postal Approved Only Mode to ensure you create an approved installation.

Your final creation will be conveniently emailed to you with both CAD and Revit formats for placement in your project and easily quoted by an Authorized Florence Dealer for costing purposes.



Exceptional Customer Service

 florencemailboxes.com/customerservice

Florence Corporation is proud to provide a complete support team to serve your needs. Not only are our friendly customer service representatives ready to assist you in locating an Authorized Dealer or answering your product questions, but a full team of engineering, design, manufacturing, quality, marketing, and sales professionals are available to answer your questions too.

Our dedicated team will:

- Ensure your project includes the correct product to solve your centralized mail delivery needs
- Help guide you through current postal regulations
- Assist you in determining the correct product solution for your existing mailbox installation that may need replacing or refurbishing
- Connect you with the right partner who will find you the right product solution

As your partner in mailbox and package solutions since 1934, Florence understands the importance of personalized service.

Authorized Florence Dealer Network

 florencemailboxes.com/dealer-network

To ensure your project goes smoothly from conception to construction, our nationwide network of Authorized Florence Dealers is ready to assist you every step of the way:

- Quote information on large jobs
- Help you select the right products for your project
- Provide technical assistance, and even in some cases install everything for you.

Florence Dealers can:

- Assist with replacement and refurbishment of current mailbox installations
- Help navigate local postal requirements to ensure mail delivery is not disrupted for your tenants
- Work with your local resources to ensure proper placement for new mailbox installations



By purchasing products directly through factory-authorized distributors, you are guaranteed local, friendly service to help guide you throughout the entire process; providing you with a trusted resource even after the sale.

Replacement Parts

IMPORTANT PRODUCT INFO



florencemailboxes.com/replacement

Product and Manufacturer Serial Tags

When attempting to determine what replacement parts you may need, begin by simply reviewing the labels attached to the product. Typically the manufacturer contact information can be found on labels either on the front lower right, or back of the product. If no label exists, just take a photograph of the product and email it to us, we'll help you identify exactly what you are looking for!



Product Door Type

Another way to identify the mailbox type for replacement purposes is by the shape of the compartments.



The tall and skinny doors are from the vertical mailbox line (pg 44).



A square door is most likely in the horizontal mailbox lines (pg 36).



The wider rectangular doors are in CBU (pg 6) or 4C (pg 10).

Replacement Parts

Looking to repair your older mailboxes? Chances are Florence can bring new life to the unit with replacement parts such as doors, locks, keys, and various standard parts. When the situation calls for basic repairs rather than replacing the entire unit, simply contact an Authorized Florence Dealer or visit our website for assistance.

(To find an Authorized Dealer near you, visit our online Dealer Locator.)



Replacement Keys

The loss of a mailbox key can be a frustrating experience. For emergency key situations, contact a local locksmith or hardware store. Otherwise, the entire lock mechanism for the mailbox compartment will need to be replaced. Work with your local postal carrier to gain access to the appropriate compartment as needed.

(Make sure to have manufacturer and number from the key handy for reference.)



Good to Know

IMPORTANT PRODUCT INFO

5 YEAR PRODUCT WARRANTY

Product Warranty

Florence Corporation provides a five-year warranty on its products from the date of shipment when purchased from an Authorized Florence Dealer. Full details on the warranty, as well as how to find a local product expert nearest you, can be found by visiting our website or calling us today!

 florencemailboxes.com/warranty

Social Media

Follow and/or like us on the popular social media platforms so together we can further the discussion on centralized mail delivery, its products, and other topics of interest in the industry. Be sure to also check out our blog where we regularly share pertinent topics of interest as you design and install your mailbox system; and subscribe to our YouTube channel where you can find product feature and 'how-to' videos.



Made in the USA

Located in the American Heartland, Florence Corporation has proudly made centralized mail delivery and storage equipment since 1934. Our approach to manufacturing and quality control allows us to effectively and efficiently produce and ship product from our Manhattan, Kansas, facility. Our long standing American tradition and operation continues to be ISO certified for both our manufacturing and management processes as well as our environmental practices.

 florencemailboxes.com/made-in-the-usa



Materials

All product descriptions and specifications contained herein were in effect at the time the catalog received final approval for printing. Note that not all powder coat color finishes are available on all Florence product lines; see individual product listings for details. Pantone color numbers shown with finishes are for reference purposes only. Printed colors shown may vary slightly due to printing process. As Florence Corporation continually strives for efficiencies to pass along to our customers, we reserve the right to change specifications and/or designs without notice and without liability. Where appropriate, replacement items will be maintained during potential transition.

Return Policy

All product shipments are adequately packaged, but should be thoroughly inspected upon receipt and prior to acceptance, for potential damage in transit. Returned goods will not be accepted without an RGA (returned goods authorization) number, which must be obtained from the Authorized Florence Dealer with whom you completed the transaction. In the event a product is authorized for a return, a minimum 30% restock fee will apply for standard stock products. Outbound freight and return freight is not credited as part of the return. Custom orders and orders with options cannot be cancelled and will not be accepted for return, exchange, or refund.



Care and Cleaning

The surface of all Florence clear aluminum or powder coated products may be cleaned of dirt or grime with a soft cloth dampened with any mild detergent or properly diluted biodegradable, water-based cleaner, such as "Simple Green™".

Wipe from top to bottom to avoid run-down. Avoid use of abrasives, which might damage the product surface. Rinse with plain water and dry. Avoid cleaning during extreme temperature conditions. Matching touch-up paint products may be available from an Authorized Florence Dealer for products which utilize powder coating.

Full details can be found at:

 florencemailboxes.com/cleaning

Copyright: Florence Corporation has made every effort possible to ensure the accuracy of all information contained within this publication. We reserve the right to correct inadvertent or typographical errors, inaccuracies or omissions - should they happen to occur - and to change or update information at any time without prior notice. All publication elements, including but not limited to, design, graphics, text, trademarks, art, and photographs, as well as the selection and arrangement thereof, are Copyright © 2018 Florence Corporation. All Rights Reserved. This catalog is intended for distribution by Florence Corporation and its Authorized Dealers for the sole purpose of purchasing products contained herein. Any other use of this publication, including modification or re-publication of any portion of the publication, without the prior written consent of Florence Corporation, is strictly prohibited. Printed in the USA on recycled paper.

Your Trusted Partner in Commercial and Residential Centralized Mailbox Designs for Over 85 Years!

Like all great stories, ours started in a garage – with elbow grease and a sweaty brow. It's that kind of story. More than 85 years later, we're still hard at it; continually perfecting our craft, allowing you to perfect yours. You may take our products for granted. We take that as a compliment. Our products don't require attention or fuss. They're built smart, designed to work, and engineered to last.

We empower our customers with the products, the support, and the tools to design faster. Build smarter. Manage better. We understand that in a world of global commerce, demands of efficiency and last minute deadlines, you need a partner that can keep pace. You've met your match with Florence. Established. Dependable. Strong. It's not just what we make...it's what makes us.

FLORENCE
CORPORATION
Established. Dependable. Strong.

800.275.1747

FlorenceMailboxes.com

