

Washroom Accessories



6 DESIGN COLLECTIONS 20 CURATED CATEGORIES



PARTITIONS

A wide range of partitions designed to enhance any interior.



WASHROOM ACCESSORIES

The most comprehensive selection of washroom accessories available anywhere.



Navigate the catalog by

Collection:
design coordinated products,
Pages 4 & 5.

Product Category:
e.g. Paper Towel Dispensers,
Pages 6 & 7.

Index:
Model No. or Category,
Pages 160-163.



LOCKERS + BENCHES

Available to be built in any configuration matrix with multiple base options, tiers, and styles to choose from.



VISUAL DISPLAY PRODUCTS

Through constant research, innovation, and development, we design and manufacture high quality visual display products that are easy to install and require little maintenance.

6 COLLECTIONS / 3 TIERS

Good



Better



Best



Simplicity™

The Beautiful Simple



P.16

Roval™

Overarching The Form



P.24

Traditional™

The Original



P.32



Matte Black

Trending Crossover

P.42

WASHROOM ACCESSORIES

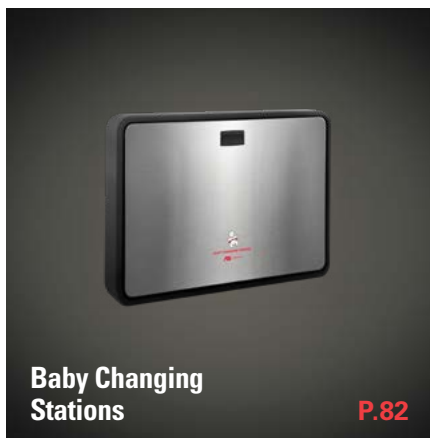
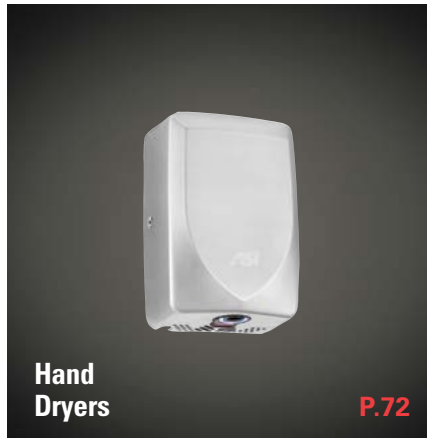

TOILET ACCESSORIES

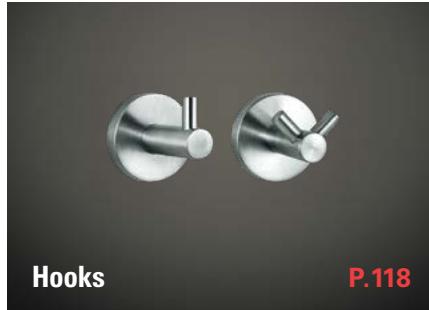

ADDITIONAL ACCESSORIES

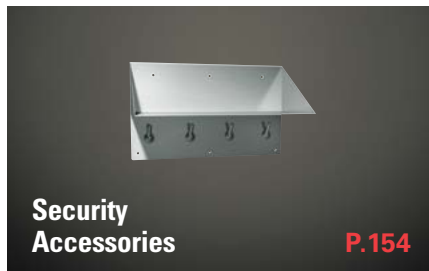
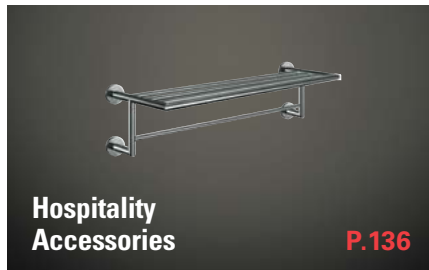
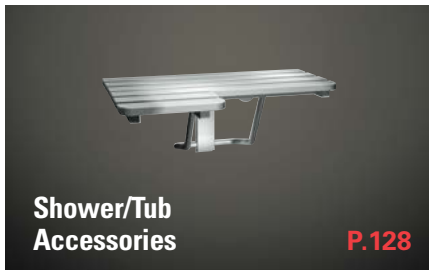



PIATTO™ COLLECTION DETAILS

COMPLETELY
RECESSED

UNIQUE DESIGN

100% coplanar with the wall
— zero protrusion.

PHENOLIC
DOORS

**ELEVATED STYLE—
A NEW CHOICE**

Phenolic doors in matte
black or white.

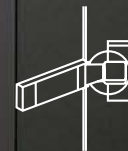

**CONCEALED LOCKS,
NO VISIBLE HARDWARE**

Fully concealed hardware,
3D-adjustable hinges.

PIATTO™ COLLECTION

The Flush Finesse

Its industry-wide unique design makes Piatto completely flush with the wall, as its silent doors do not have any protrusion.



THREE-WAY ADJUSTABLE HINGE

An innovative hinge technology allows cabinet and doors to be completely recessed, with no protrusions from the plane of the wall surface. Silent doors can be adjusted in the field.

- Phenolic Doors
- Completely Recessed Mounting
- Concealed Internal Spring-Loaded Latch
- No Visible Hardware



6467
**PIATTO™ PAPER TOWEL DISPENSER
 AND WASTE RECEPTACLE**

800 MULTI-FOLD
 OR 600 C-FOLD
 PAPER TOWELS

4.2 gal.
 WASTE CAPACITY
 (16 L)

MANUAL
 DISPENSING

Model Options:
6467-00 White Door.
6467-41 Matte Black Door.

Unit Size:
 13" x 55" x 4⁹/₁₆"
 (330 x 1397 x 116 mm)

Finished Wall Opening*:
 13⁷/₁₆" x 55¹/₁₆" x 4¹¹/₁₆"
 (332 x 1399 x 119 mm)



64623
**PIATTO™ PAPER TOWEL DISPENSER
 AND WASTE RECEPTACLE**

475 MULTI-FOLD
 OR 350 C-FOLD
 PAPER TOWELS

2.2 gal.
 WASTE CAPACITY
 (8.4 L)

MANUAL
 DISPENSING

Model Options:
64623-00 White Door.
64623-41 Matte Black Door.

Unit Size:
 14¹/₄" x 28" x 4⁹/₁₆"
 (362 x 711 x 116 mm)

Finished Wall Opening*:
 14⁵/₁₆" x 28⁷/₁₆" x 4¹¹/₁₆"
 (364 x 713 x 119 mm)



6457
PIATTO™ PAPER TOWEL DISPENSER

475 MULTI-FOLD
 OR 350 C-FOLD
 PAPER TOWELS

MANUAL
 DISPENSING

Model Options:
6457-00 White Door.
6457-41 Matte Black Door.

Unit Size:
 12³/₄" x 17¹/₄" x 4⁹/₁₆"
 (324 x 438 x 116 mm)

Finished Wall Opening*:
 12¹³/₁₆" x 17⁵/₁₆" x 4³/₄"
 (325 x 440 x 121 mm)



6474-00
PIATTO™ WASTE RECEPTACLE

12 gal.
 WASTE CAPACITY
 (46 L)

Model Options:
6474-00 White Door.
6474-41 Matte Black Door.

Unit Size:
 17¹/₄" x 40" x 6⁹/₁₆"
 (438 x 1016 x 166 mm)

Finished Wall Opening*:
 17⁵/₁₆" x 40¹/₁₆" x 6¹¹/₁₆"
 (440 x 1018 x 170 mm)

ALL STAINLESS STEEL IS TYPE 304 WITH SATIN FINISH, UNLESS OTHERWISE NOTED.

*All Piatto™ models require finished wall openings for installation. The edges of the finished wall opening are meant to be visible after installation, hence edges must be flat, square, straight, and plumb—no rough or unsightly edges.



6462
PIATTO™ PAPER TOWEL DISPENSER
AND WASTE RECEPTACLE

800 MULTI-FOLD
OR 600 C-FOLD
PAPER TOWELS

9 gal.
WASTE CAPACITY
(34 L)

MANUAL
DISPENSING

Model Options:
6462-00 White Door.
6462-41 Matte Black Door.

Unit Size:
17¼" x 54" x 6⅞"
(438 x 1372 x 166 mm)

Finished Wall Opening*:
17⅝" x 54⅞" x 6⅞"
(440 x 1373 x 170 mm)



64696A/AC
PIATTO™ AUTOMATIC ROLL PAPER TOWEL
DISPENSER AND WASTE RECEPTACLE

UP TO 800 ft.
(244 M) LONG ROLL
TOWEL CAPACITY

9.9 gal.
WASTE CAPACITY
(37.3 L)

NO-TOUCH
DISPENSING

Model Options:
64696A-00 White Door.
64696A-41 Matte Black Door.
64696AC-00 White Door.
64696AC-41 Matte Black Door.

Unit Size:
16⅞" x 41¼" x 9⅞"
(408 x 1048 x 246 mm)

Finished Wall Opening*:
16⅞" x 41⅝" x 10"
(410 x 1049 x 254 mm)



645210A/AC
PIATTO™ AUTOMATIC ROLL PAPER TOWEL DISPENSER

UP TO 800 ft.
(244 M) LONG ROLL
TOWEL CAPACITY

NO-TOUCH
DISPENSING

Model Options:
645210A-00 White Door.
645210A-41 Matte Black Door.
645210AC-00 White Door.
645210AC-41 Matte Black Door.

Unit Size:
16⅞" x 28" x 9⅞"
(408 x 711 x 248 mm)

Finished Wall Opening*:
16⅞" x 28⅞" x 10"
(410 x 713 x 254 mm)



64672-1
PIATTO™ COMPLETELY RECESSED 3-IN-1 PAPER TOWEL
DISPENSER, HIGH-SPEED HAND DRYER, AND
WASTE RECEPTACLE

500 MULTI-FOLD
OR 400 C-FOLD
PAPER TOWELS

6.8 gal.
WASTE CAPACITY
(26 L)

<15 sec.
DRYING TIME

MANUAL
DISPENSING

Model Options:
64672-1-00 White Door.
64672-1-41 Matte Black Door.

Unit Size:
15⅝" x 55⅝" x 7⅞"
(391 x 1407 x 191 mm)

Finished Wall Opening*:
15⅞" x 55⅞" x 7⅞"
(392 x 1408 x 194 mm)

Noise Level: 68.9-74.3 dBA



VELARE™ COLLECTION DETAILS

ARTFULLY CONCEALED

ARTFULLY CONCEALED

Consumables are concealed behind the mirror.

SOAP



CONCEALED SOAP DISPENSER

High-capacity foam or liquid soap dispenser makes Velare™ ideal for high-frequency-use restrooms.

TOWEL



PAPER TOWEL OPTION

Velare™ provides paper towels as an option for drying hands. 500 towel capacity.

AIR



HAND DRYER OPTION

Optional high-speed, low-decibel hand dryer is equipped with a HEPA filter.

VELARE™ COLLECTION

The Concealed Elegance

An elegant solution for a clean and sleek washroom appearance, where humble design meets comfort and function.

ALL-IN-ONE Cabinet houses a
– paper towel dispenser or high-speed hand dryer and
– a liquid soap- or foam-soap dispenser
Collection includes mirror fillers for design flexibility.

Backlit icons etched into the mirror facilitate an intuitive user experience.





0661-1
VELARE™ STAINLESS STEEL CABINET WITH
FRAMELESS MIRROR, LIQUID SOAP DISPENSER,
AND HIGH-SPEED HAND DRYER (110-120 V)



AIR

68-73.8
 NOISE LEVEL



LIQUID SOAP

Model Option:
0661-2 Velare™ Stainless Steel Cabinet with Liquid Soap
 and Hand Dryer (208-240 V).

Overall Dimensions:
 $23\frac{3}{8}'' \times 35\frac{7}{16}'' \times 7\frac{9}{16}''$
 (600 x 900 x 192 mm)



0661-T
VELARE™ STAINLESS STEEL CABINET WITH
FRAMELESS MIRROR, LIQUID SOAP DISPENSER,
AND PAPER TOWEL DISPENSER

500

PAPER TOWELS



LIQUID SOAP

.4 GAL. (1.5 L).
 CAPACITY

Overall Dimensions:
 $23\frac{3}{8}'' \times 35\frac{7}{16}'' \times 7\frac{9}{16}''$
 (600 x 900 x 192 mm)



0661-FM-14
VELARE™ STAINLESS STEEL FRAMELESS
MIRROR FILLER MODULE

SURFACE
 MOUNTED

Overall Dimensions:
 $14\frac{3}{4}'' \times 35\frac{7}{16}'' \times 7\frac{9}{16}''$
 (375 x 900 x 192 mm)



0661-FM-23
VELARE™ STAINLESS STEEL FRAMELESS
MIRROR FILLER MODULE

SURFACE
 MOUNTED

Overall Dimensions:
 $23\frac{1}{4}'' \times 35\frac{7}{16}'' \times 7\frac{9}{16}''$
 (591 x 900 x 192 mm)



0663-1
VELARE™ STAINLESS STEEL CABINET WITH FRAMELESS MIRROR, FOAM SOAP DISPENSER, AND HIGH-SPEED HAND DRYER (110-120 V)

 AIR
  **68-73.8** dBA NOISE LEVEL
  FOAM SOAP

Model Option:
0663-2 Velare™ Stainless Steel Cabinet with Foam Soap and Hand Dryer (208-240 V).

Overall Dimensions:
 23⁵/₁₆" x 35⁷/₁₆" x 7⁹/₁₆"
 (600 x 900 x 192 mm)



0663-T
VELARE™ STAINLESS STEEL CABINET WITH FRAMELESS MIRROR, FOAM SOAP DISPENSER, AND PAPER TOWEL DISPENSER

 **500** PAPER TOWELS
  FOAM SOAP
  **.4 GAL. (1.5L).** CAPACITY

Overall Dimensions:
 23⁵/₁₆" x 35⁷/₁₆" x 7⁹/₁₆"
 (600 x 900 x 192 mm)

Velare™ minimizes the hazards of water spilling on the floor after the handwashing process by housing drying and soap components directly above the sink.

This marriage of elegance and functionality makes Velare™ ideal for a wide range of PREMIUM building types, such as sophisticated corporate headquarters.





SIMPLICITY™ COLLECTION DETAILS



SIMPLY CONCEALED

Presenting itself in a sleek and streamlined appearance, the 18-gauge stainless steel door is attached with concealed $\frac{3}{16}$ " (5 mm) diameter full-



SAFE, EASY DISPENSING

Towel dispensers have hemmed opening for safe, easy dispensing, minimizing waste, and ensuring hygienic use.



EASY LIFT OUT RECEPTACLE

Fully removable stainless steel waste cans allow contents to be easily discarded for efficient ongoing maintenance and cleanliness.



SIMPLICITY™ COLLECTION

The Beautiful Simple

The Simplicity Collection's minimalist design and humble timelessness simply complement other designs in the washroom.

SIMPLICITY™ COLLECTION
ALL STAINLESS STEEL IS TYPE 304 WITH SATIN FINISH,
UNLESS OTHERWISE NOTED.



**PAPER TOWEL
DISPENSERS**



**PAPER TOWEL
DISPENSERS**



**SOAP
DISPENSERS**



6467

**SIMPLICITY™ RECESSED
PAPER TOWEL DISPENSER AND
WASTE RECEPTACLE**

800 MULTI-FOLD
OR 600 C-FOLD
PAPER TOWELS

4.2 gal.
WASTE CAPACITY
(16 L)

Model Options:

6467-41PC Matte Black
6467-9 Surface mounted with a
stainless steel collar.
6467-9-41PC Surface mounted with
a matte black stainless steel collar.

Unit Size:
13" x 55" x 4¾"
(330 x 1397 x 121 mm)

Wall Opening:
11½" x 53½" x 4"
(292 x 1359 x 102 mm)

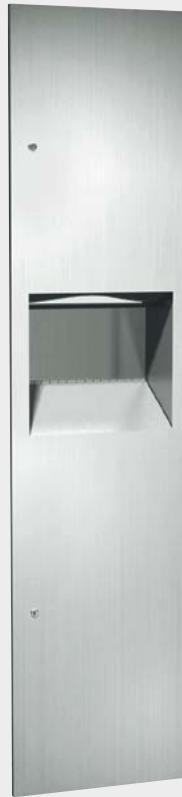

64676

**SIMPLICITY™ RECESSED
PAPER TOWEL DISPENSER AND
WASTE RECEPTACLE**

800 MULTI-FOLD
OR 600 C-FOLD
PAPER TOWELS

7 gal.
WASTE CAPACITY
(26.5 L)

Model Options:

64676-2 Semi-recessed with a
stainless steel collar.
64676-9 Surface mounted with a
stainless steel collar.

Unit Size:
13" x 55" x 6½"
(330 x 1397 x 165 mm)

Wall Opening:
11½" x 53½" x 6"
(292 x 1359 x 152 mm)



6462

**SIMPLICITY™ RECESSED
PAPER TOWEL DISPENSER AND
WASTE RECEPTACLE**

800 MULTI-FOLD
OR 600 C-FOLD
PAPER TOWELS

9 gal.
WASTE CAPACITY
(34 L)

Model Options:

6462-2 Semi-recessed with a
stainless steel collar.
6462-9 Surface mounted with a
stainless steel collar.

Unit Size:
17¼" x 54" x 6½"
(438 x 1372 x 165 mm)

Wall Opening:
15¾" x 52½" x 6"
(400 x 1335 x 152 mm)



64623
SIMPLICITY™ RECESSED PAPER TOWEL DISPENSER
AND WASTE RECEPTACLE

475 MULTI-FOLD
OR 350 C-FOLD
PAPER TOWELS

2.2 gal.
WASTE CAPACITY
(8.4 L)

MANUAL
DISPENSING

Model Options:
64623-41PC Matte Black.
64623-9 Surface mounted with a stainless steel collar.
64623-9-41PC Surface mounted with a matte black stainless steel collar.

Unit Size:
14¼" x 28" x 4¾"
(362 x 711 x 121 mm)

Wall Opening:
12¾" x 26½" x 4¼"
(324 x 673 x 108 mm)



6452
SIMPLICITY™ RECESSED PAPER TOWEL DISPENSER

800 MULTI-FOLD
OR 600 C-FOLD
PAPER TOWELS

MANUAL
DISPENSING

Model Option:
6452-9 Surface mounted with a stainless steel collar.

Unit Size:
14¼" x 28" x 4½"
(362 x 711 x 114 mm)

Wall Opening:
12¾" x 26½" x 4¼"
(324 x 673 x 108 mm)



6457
SIMPLICITY™ RECESSED PAPER TOWEL DISPENSER

475 MULTI-FOLD
OR 350 C-FOLD
PAPER TOWELS

MANUAL
DISPENSING

Unit Size:
12¾" x 17¼" x 4½"
(324 x 438 x 114 mm)

Wall Opening:
11¼" x 15¼" x 4¼"
(286 x 400 x 108 mm)



6459
SIMPLICITY™ RECESSED WASTE RECEPTACLE

4 gal.
WASTE CAPACITY
(15 L)

Unit Size:
14¼" x 28" x 4½"
(362 x 711 x 114 mm)

Wall Opening:
12¾" x 26½" x 4¼"
(324 x 673 x 108 mm)



6474
**SIMPLICITY™ RECESSED
 WASTE RECEPTACLE**

12 gal.

WASTE CAPACITY
 (45.4 L)

Model Options:

- 6474-41PC** Matte Black.
- 6474-2** Semi-recessed with a stainless steel collar.
- 6474-2-41PC** Matte Black.

Unit Size:

17¼" x 40" x 6¼"
 (438 x 1016 x 171 mm)

Wall Opening:

15¾" x 38½" x 6¼"
 (400 x 978 x 159 mm)



64696A
**SIMPLICITY™ AUTOMATIC
 RECESSED ROLL PAPER
 TOWEL DISPENSER AND
 WASTE RECEPTACLE**

UP TO 800 ft. 9.9 gal.
(244 M) LONG ROLL WASTE CAPACITY
TOWEL CAPACITY (37.3 L)

**SUFFIX OPTIONS FOR
 POWER/MOUNTING:**

[A, A-6, A-9, AC, AC-6, AC-9]

A: Powered by 4 D-size batteries (not included).

AC: Powered by AC plug-in adapter.

-6: Semi-recessed with a stainless steel collar.

-9: Surface mounted with a stainless steel collar.

Unit Size:

16⅞" x 41¼" x 10¼"
 (408 x 1048 x 261 mm)

Wall Opening:

14⅞" x 39¾" x 10"
 (371 x 1010 x 254 mm)



645210A
**SIMPLICITY™ AUTOMATIC
 RECESSED ROLL PAPER
 TOWEL DISPENSER**

UP TO 800 ft. NO-TOUCH
(244 M) LONG ROLL DISPENSING
TOWEL CAPACITY

**SUFFIX OPTIONS FOR
 POWER/MOUNTING:**

[A, A-6, A-9, AC, AC-6, AC-9]

A: Powered by 4 D-size batteries (not included).

AC: Powered by AC plug-in adapter.

-6: Semi-recessed with a stainless steel collar.

-9: Surface mounted with a stainless steel collar.

Unit Size:

16⅞" x 28" x 9"
 (408 x 711 x 229 mm)

Wall Opening:

15¾" x 26½" x 10¼"
 (400 x 673 x 260 mm)



68523A-4
SIMPLICITY™ AUTOMATIC SEMI-RECESSED ROLL PAPER TOWEL DISPENSER

UP TO 800 ft. NO-TOUCH
 (244 M) LONG ROLL DISPENSING TOWEL CAPACITY

Model Options:

- 68523A** battery operated, surface mounted.
- 68523AC** roll towel dispenser, 110-240 VAC, surface mounted.
- 68523AC-4** roll towel dispenser, 110-240 VAC, semi-recessed.

Unit Size:
 17¹/₈" x 20³/₈" x 9¹/₂"
 (440 x 518 x 241 mm)

Wall Opening:
 15³/₈" x 19" x 4"
 (391 x 483 x 102 mm)



645224AC
SIMPLICITY™ AUTOMATIC RECESSED ROLL PAPER TOWEL DISPENSER

UP TO 800 ft. NO-TOUCH
 (244 M) LONG ROLL DISPENSING TOWEL CAPACITY

SUFFIX OPTIONS FOR POWER/ MOUNTING: [A, A-6, AC, AC-6, AC-9]

- AC:** Powered by AC plug-in adapter.
- 6:** Semi-recessed with a stainless steel collar.
- 9:** Surface mounted with a stainless steel collar.

Unit Size:
 17¹/₄" x 30¹/₂" x 10¹/₄"
 (438 x 775 x 260 mm)

Wall Opening:
 15³/₄" x 29" x 4"
 (400 x 737 x 102 mm)



646924A
SIMPLICITY™ AUTOMATIC RECESSED ROLL PAPER TOWEL DISPENSER AND WASTE RECEPTACLE

UP TO 800 ft. 12 gal.
 (244 M) LONG ROLL DISPENSING TOWEL CAPACITY WASTE CAPACITY (45.4 L)

SUFFIX OPTIONS FOR POWER/ MOUNTING: [A, A-9, AC, AC-9]

- A:** Powered by 4 D-size batteries (not included).
- AC:** Powered by AC plug-in adapter.
- 9:** Surface mounted with a stainless steel collar.

Unit Size:
 17¹/₄" x 56" x 10¹/₄"
 (438 x 1422 x 260 mm)

Wall Opening:
 15³/₄" x 54¹/₂" x 4"
 (400 x 1384 x 102 mm)



0326
**SIMPLICITY™ HORIZONTAL
 RECESSED LIQUID
 SOAP DISPENSER**

57 oz.
 CAPACITY

Overall Dimensions:
 10¼" x 6" x 4½"
 (260 x 152 x 115 mm)

Wall Opening:
 9" x 4⅞" x 4"
 (229 x 124 x 102 mm)

Sput Projection: 2½" (64 mm)



64696
**SIMPLICITY™ RECESSED ROLL
 PAPER TOWEL DISPENSER AND
 WASTE RECEPTACLE**

UP TO 800 ft. **9.4 gal.**
 (244 M) LONG ROLL WASTE CAPACITY
 TOWEL CAPACITY (36 L)

Model Options:
64696-6 Semi-recessed with a stainless steel collar.
64696-9 Surface mounted with a stainless steel collar.

Unit Size:
 16⅞" x 41¼" x 9⅞"
 (408 x 1048 x 245 mm)

Wall Opening:
 14⅞" x 39¾" x 9¼"
 (371 x 1010 x 235 mm)



64672-1
**SIMPLICITY™ RECESSED 3-IN-1
 PAPER TOWEL DISPENSER,
 HIGH-SPEED HAND DRYER,
 AND WASTE RECEPTACLE**

500 MULTI-FOLD **6.8 gal.**
 OR 400 C-FOLD WASTE CAPACITY
 PAPER TOWELS (26 L)

Model Options:
64672-2 Dryer Voltage is 208-240 V Dryer.
64672 Cabinet only—no hand dryer included.
64672-41PC Cabinet Only—Matte Black.

Unit Size:
 15⅞" x 55⅞" x 7½"
 (391 x 1407 x 191 mm)

Wall Opening:
 14⅞" x 54⅞" x 7¼"
 (358 x 1381 x 184 mm)

Noise Level: 68.9-74.3 dBA



0135-1
TURBO-TUFF™ RECESSED HIGH-SPEED
ADA HAND DRYER (110-120V)

<15 sec.
 DRYING TIME

68.9-74.3 dBA
 NOISE LEVEL

Auto Shut Off: 60 seconds

Model Options:
0135-2 Voltage is 208-240 V

Unit Size:
 12¹⁹/₃₂" x 15³/₄" x 4¹/₃₂"
 (320 x 400 x 102 mm)

Wall Opening:
 12⁵/₁₆" x 15³/₁₆" x 3⁷/₈"
 (313 x 386 x 98 mm)



6471
SIMPLICITY™ RECESSED SANITARY NAPKIN DISPOSAL

1.4 gal.
 WASTE CAPACITY
 (5.4 L)

Unit Size:
 10⁹/₈" x 19⁵/₈" x 4¹/₂"
 (270 x 498 x 114 mm)

Wall Opening:
 9¹/₈" x 18¹/₈" x 4"
 (232 x 460 x 102 mm)



6477
SIMPLICITY™ RECESSED TOILET SEAT COVER DISPENSER

500 SINGLE
 OR HALF-FOLD
 PAPER SEAT
 COVERS

Unit Size:
 17¹/₄" x 12³/₄" x 2⁷/₈"
 (438 x 324 x 73 mm)

Wall Opening:
 15³/₄" x 11¹/₂" x 2³/₈"
 (400 x 292 x 60 mm)



6468
SIMPLICITY™ RECESSED DUAL NAPKIN/TAMPON VENDOR

27
 TAMPON
 CAPACITY

Model Option:
64684 designed for 4" (102 mm) wall opening; dispenses 15 napkins and 23 tampons.

Unit Size:
 17¹/₄" x 27¹/₄" x 6¹/₂"
 (438 x 692 x 165 mm)

Wall Opening:
 16" x 26" x 6¹/₄"
 (406 x 660 x 159 mm)



ROVAL™ COLLECTION DETAILS



ARCH-SHAPED SURFACES

Contrasting character of outstanding arch-shaped surfaces.



INTEGRAL LOCKING SYSTEM

Our durable, integral locking system prevents tampering and theft.

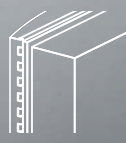

STAKED PIANO HINGES

Our heavy-duty staked piano hinges provide security and a neat appearance, and they stand up to heavy use.



REMOVABLE WASTE RECEPTACLE

Fully removable waste cans allow contents to be easily discarded for efficient ongoing maintenance and cleanliness.

ROVAL™ COLLECTION

Overarching The Form

The Roval Collection's arch-shaped surfaces offer a dialogue of tactile and visual contrast in the washroom, transforming accessories into an aesthetic gesture.



**MANUAL AND
AUTOMATIC
PAPER TOWEL/
TOILET TISSUE
DISPENSERS**



MIRRORS



**AUTOMATIC
HAND DRYERS**



20469

ROVAL™ RECESSED PAPER TOWEL DISPENSER AND WASTE RECEPTACLE

800 MULTI-FOLD
OR 600 C-FOLD
PAPER TOWELS

14.8 gal.
WASTE CAPACITY
(56 L)

MANUAL
DISPENSING

Model Option:

20469-9 Surface mounted with a stainless steel collar.

Unit Size:

17³/₈" x 56¹/₁₆" x 9"
(441 x 1424 x 228 mm)

Wall Opening:

15⁵/₈" x 54³/₈" x 4"
(397 x 1381 x 102 mm)



204623

ROVAL™ RECESSED PAPER TOWEL DISPENSER AND REMOVABLE WASTE RECEPTACLE

475 MULTI-FOLD
OR 350 C-FOLD
PAPER TOWELS

3 gal.
WASTE CAPACITY
(11.2 L)

MANUAL
DISPENSING

Model Option:

204623-9 Surface mounted with a stainless steel collar.

Unit Size:

12³/₄" x 28" x 6¹/₂"
(325 x 710 x 165 mm)

Wall Opening:

11¹/₄" x 26⁷/₁₆" x 3¹⁵/₁₆"
(286 x 672 x 100 mm)

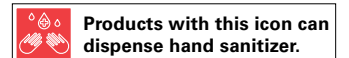



20210
ROVAL™ SURFACE MOUNTED PAPER TOWEL DISPENSER

525 MULTI-FOLD **MANUAL**
 OR 400 C-FOLD PAPER TOWELS **DISPENSING**

Overall Dimensions:
 11¹/₁₆" x 13⁹/₁₆" x 4⁷/₁₆"
 (281 x 345 x 124 mm)



20826
ROVAL™ SURFACE MOUNTED WASTE RECEPTACLE

12.8 gal.
WASTE CAPACITY
 (48.4 L)

Model Option:
20826-T Closed top, spring-loaded door. Capacity 12.8 gal. (48.4 L).

Overall Dimensions:
 15¹/₈" x 23" x 8¹/₂"
 (384 x 584 x 216 mm)



9343
HORIZONTAL SURFACE MOUNTED SOAP DISPENSER

48 oz.
CAPACITY

Model Option:
9343-41 Matte Black.

Overall Dimensions:
 7¹/₄" x 6¹/₂" x 3¹/₁₆"
 (184 x 165 x 94 mm)

Spout Projection:
 1⁵/₁₆" (24 mm)



20364
ROVAL™ AUTOMATIC SURFACE MOUNTED LIQUID SOAP AND GEL HAND SANITIZER DISPENSER

34 oz. NO-TOUCH
CAPACITY DISPENSING

Overall Dimensions:
 5¹/₂" x 10¹³/₁₆" x 4"
 (140 x 274 x 102 mm)



20365
ROVAL™ AUTOMATIC SURFACE MOUNTED FOAM SOAP AND HAND SANITIZER DISPENSER

34 oz. NO-TOUCH
CAPACITY DISPENSING

Overall Dimensions:
 5¹/₂" x 10¹³/₁₆" x 4"
 (140 x 274 x 102 mm)



20363
ROVAL™ SURFACE MOUNTED LIQUID SOAP DISPENSER

57 oz.
CAPACITY

Overall Dimensions:
 5¹/₂" x 10¹³/₁₆" x 4"
 (139 x 274 x 102 mm)

Spout Projection:
 1⁵/₁₆" (24 mm)



20452
ROVAL™ RECESSED PAPER TOWEL DISPENSER

800 MULTI-FOLD
 OR 600 C-FOLD
 PAPER TOWELS

MANUAL
 DISPENSING

Overall Dimensions:
 12³/₄" x 28" x 5⁷/₁₆"
 (324 x 711 x 137 mm)

Wall Opening:
 11¹/₄" x 26⁷/₁₆" x 3¹⁵/₁₆"
 (286 x 672 x 100 mm)



20458
**ROVAL™ SEMI-RECESSED REMOVABLE
 WASTE RECEPTACLE**

11.2 gal.
 WASTE CAPACITY
 (42.6 L)

Unit Size:
 17³/₈" x 27³/₄" x 8¹⁵/₁₆"
 (441 x 705 x 227 mm)

Wall Opening:
 15³/₄" x 26" x 3¹⁵/₁₆"
 (400 x 660 x 100 mm)



204692A

ROVAL™ AUTOMATIC RECESSED ROLL PAPER TOWEL DISPENSER AND WASTE RECEPTACLE

UP TO 800 ft.
(244 M) LONG ROLL
TOWEL CAPACITY

17.8 gal.
WASTE CAPACITY
(67.2 L)

NO-TOUCH
DISPENSING

**SUFFIX OPTIONS FOR POWER/MOUNTING:
[A, A-6, A-9, AC, AC-6, AC-9]**

- A:** Powered by 4 D-size batteries (not included).
- AC:** Powered by AC plug-in adapter.
- 6:** Semi-recessed with a stainless steel collar.
- 9:** Surface mounted with a stainless steel collar.

Unit Size:
17³/₈" x 56¹/₁₆" x 11¹¹/₁₆"
(441 x 1424 x 297 mm)

Wall Opening:
15¹³/₁₆" x 54¹¹/₁₆" x 10"
(402 x 1389 x 254 mm)



2046921A

ROVAL™ AUTOMATIC RECESSED ROLL PAPER TOWEL DISPENSER AND WASTE RECEPTACLE FOR ADA COMPLIANCE

UP TO 800 ft.
(244 M) LONG ROLL
TOWEL CAPACITY

13.5 gal.
WASTE CAPACITY
(51.1 L)

NO-TOUCH
DISPENSING

**SUFFIX OPTIONS FOR POWER/MOUNTING:
[A, A-6, A-9, AC, AC-6, AC-9]**

- A:** Powered by 4 D-size batteries (not included).
- AC:** Powered by AC plug-in adapter.
- 6:** Semi-recessed with a stainless steel collar.
- 9:** Surface mounted with a stainless steel collar.

Unit Size:
17³/₈" x 56¹/₁₆" x 11¹¹/₁₆"
(441 x 1424 x 296 mm)

Wall Opening:
15¹³/₁₆" x 54¹¹/₁₆" x 10"
(402 x 1389 x 254 mm)



204523A
ROVAL™ AUTOMATIC RECESSED ROLL PAPER TOWEL DISPENSER

UP TO 800 ft. NO-TOUCH
(244 M) LONG ROLL DISPENSING
TOWEL CAPACITY

SUFFIX OPTIONS FOR POWER/MOUNTING: [A, A-6, A-9, AC, AC-6, AC-9]

A: Powered by 4 D-size batteries (not included).
AC: Powered by AC plug-in adapter.
-6: Semi-recessed with a stainless steel collar.
-9: Surface mounted with a stainless steel collar.

Unit Size:
17³/₈" x 27³/₄" x 11¹/₁₆"
(441 x 705 x 297 mm)

Wall Opening:
15³/₄" x 26" x 10"
(400 x 660 x 254 mm)



20852
ROVAL™ SURFACE MOUNTED SANITARY WASTE RECEPTACLE

1.0 gal.
WASTE CAPACITY
(3.7 L)

Overall Dimensions:
7¹/₄" x 10" x 3¹/₂"
(185 x 253 x 89 mm)



20477-SM
ROVAL™ SURFACE MOUNTED SEAT COVER DISPENSER

250 SINGLE
OR HALF-FOLD
PAPER SEAT
COVERS

Overall Dimensions:
15³/₄" x 11" x 2³/₈"
(400 x 280 x 60 mm)



20030
ROVAL™ SURFACE MOUNTED TWIN HIDE-A-ROLL TOILET TISSUE DISPENSER

2
TOILET PAPER
CAPACITY (ROLLS)

Model Option:
20031 With flange for semi-recessed mounting.

Overall Dimensions:
6¹/₁₆" x 12¹/₈" x 6¹/₂"
(154 x 308 x 165 mm)



20470
ROVAL™ RECESSED SANITARY NAPKIN DISPOSAL

1.0 gal.
WASTE CAPACITY
(3.7 L)

Unit Size:
12¹³/₁₆" x 11" x 5⁷/₁₆"
(325 x 280 x 138 mm)

Wall Opening:
15³/₄" x 26" x 3¹/₁₆"
(400 x 660 x 100 mm)



20199
**ROVAL™ SEMI-RECESSED
 HIGH-SPEED HAND DRYER**

<15 sec.
 DRYING TIME

69 dBA
 NOISE LEVEL

Voltage: 120 V (-1) and 240 V (-2)

Unit Size:
 11" x 15½" x 5²³/₃₂"
 (279 x 394 x 145 mm)

Wall Opening:
 10½" x 14⁵/₈" x 3¼"
 (267 x 371 x 83 mm)



20655
**ROVAL™ STAINLESS STEEL MIRROR WITH
 INTEGRAL SHELF**

15 YEAR
 WARRANTY

Model Options:
 20650 Mirror without shelf.
 20655-1830 - 18" wide x 30" high (457 x 762 mm).
 20655-1836 - 18" wide x 36" high (457 x 914 mm).
 20655-2436 - 24" wide x 36" high (610 x 914 mm).



20692 SERIES
ROVAL™ SURFACE MOUNTED SHELF, 6" DEPTH

For various lengths add suffix-6XX.

See chart for standard sizes on page 90.



204684
**ROVAL™ RECESSED DUAL SANITARY NAPKIN
 AND TAMPON VENDOR**

22
 TAMPON
 CAPACITY

Model Option:
 204684-9 Surface mounted with a stainless steel collar.

Unit Size:
 17⁷/₁₆" x 27³/₄" x 5⁵/₈"
 (440 x 705 x 143 mm)

Wall Opening:
 15³/₄" x 26¹/₈" x 4"
 (397 x 664 x 102 mm)



TRADITIONAL™ COLLECTION DETAILS



SAFE, EASY DISPENSING

Towel dispensers have hemmed opening for safe, easy dispensing, minimizing waste, and ensuring hygienic use.



EASY LIFT OUT RECEPTACLE

Fully removable stainless steel waste cans allow contents to be easily discarded for efficient ongoing maintenance and cleanliness.

TRADITIONAL™ COLLECTION

The Original

The time-honored Traditional Collection provides exceptional value, offering a broad array of items in a handcrafted style with pure original beauty.



**PAPER TOWEL
DISPENSERS**



**WASTE
RECEPTACLES**



0469

TRADITIONAL™ RECESSED PAPER TOWEL DISPENSER AND WASTE RECEPTACLE

800 MULTI-FOLD
OR 600 C-FOLD
PAPER TOWELS

12 gal.
WASTE CAPACITY
(46 L)

MANUAL
DISPENSING

Model Options:

- 0469-2** Semi-recessed with a stainless steel collar.
- 0469-9** Surface mounted with a stainless steel collar.
- 0469-BL** 18 gal. (68 L) waste receptacle. Projects 8" (205 mm) from wall.

Unit Size:

17¼" x 56" x 4¼"
(438 x 1422 x 108 mm)

Wall Opening:

15¾" x 54½" x 4"
(400 x 1384 x 102 mm)



0462-AD

TRADITIONAL™ RECESSED PAPER TOWEL DISPENSER AND WASTE RECEPTACLE

475 MULTI-FOLD
OR 350 C-FOLD
PAPER TOWELS

2 gal.
WASTE CAPACITY
(7.6 L)

MANUAL
DISPENSING

Model Option:

- 0462-AD-9** Surface mounted with a stainless steel collar.

Unit Size:

14¼" x 28" x 4¼"
(362 x 711 x 108 mm)

Wall Opening:

12¾" x 26½" x 4"
(324 x 673 x 102 mm)



04697

TRADITIONAL™ RECESSED PAPER TOWEL DISPENSER AND WASTE RECEPTACLE

800 MULTI-FOLD
OR 600 C-FOLD
PAPER TOWELS

12 gal.
WASTE CAPACITY
(46 L)

MANUAL
DISPENSING

Model Options:

04697-4 Semi-recessed with a stainless steel collar.
04697-9 Surface mounted with a stainless steel collar.
04697-BL 18 gal. (68 L) waste receptacle, projects 4" (102 mm) from wall.

Unit Size:

17¼" x 56" x 7¼"
(438 x 1422 x 184 mm)

Wall Opening:

15¾" x 54½" x 7¼"
(400 x 1384 x 184 mm)



0467

TRADITIONAL™ RECESSED PAPER TOWEL DISPENSER AND WASTE RECEPTACLE

800 MULTI-FOLD
OR 600 C-FOLD
PAPER TOWELS

7 gal.
WASTE CAPACITY
(26 L)

MANUAL
DISPENSING

Model Options:

0467-2 Semi-recessed with a stainless steel collar.
0467-9 Surface mounted with a stainless steel collar.

Unit Size:

13" x 55" x 6½"
(330 x 1397 x 165 mm)

Wall Opening:

11½" x 53½" x 6¼"
(292 x 1359 x 159 mm)



0210
**TRADITIONAL™ SURFACE MOUNTED
 PAPER TOWEL DISPENSER**

525 MULTI-FOLD
 OR 400 C-FOLD
 PAPER TOWELS

**MANUAL
 DISPENSING**

Model Option:
0210-41 Matte Black.

Overall Dimensions:
 11 1/8" x 14 5/8" x 4"
 (282 x 371 x 101 mm)



0457
TRADITIONAL™ RECESSED PAPER TOWEL DISPENSER

500 MULTI-FOLD
 OR 350 C-FOLD
 PAPER TOWELS

**MANUAL
 DISPENSING**

Model Option:
0457-9 Surface mounted with a stainless steel collar.

Unit Size:
 12 3/4" x 17 1/4" x 4 1/4"
 (324 x 438 x 108 mm)

Wall Opening:
 11 1/4" x 15 3/4" x 4"
 (286 x 400 x 102 mm)



0452
TRADITIONAL™ RECESSED PAPER TOWEL DISPENSER

800 MULTI-FOLD
 OR 600 C-FOLD
 PAPER TOWELS

**MANUAL
 DISPENSING**

Model Option:
0452-9 Surface mounted with a stainless steel collar.

Unit Size:
 14 1/4" x 28" x 4 1/4"
 (326 x 711 x 108 mm)

Wall Opening:
 12 3/4" x 26 1/2" x 4"
 (324 x 673 x 102 mm)



0439
**TRADITIONAL™ PAPER TOWEL DISPENSER
 FOR BEHIND THE MIRROR**

800 MULTI-FOLD
 OR 600 C-FOLD
 PAPER TOWELS

**MANUAL
 DISPENSING**

**FOR BEHIND
 THE MIRROR**

Overall Dimensions:
 11 1/2" x 18" x 4 1/2"
 (292 x 457 x 108 mm)



0215
TRADITIONAL™ SURFACE MOUNTED
PAPER TOWEL DISPENSER – PETITE

275 MULTI-FOLD
 OR 200 C-FOLD
 PAPER TOWELS

MANUAL
 DISPENSING

Overall Dimensions:
 11" x 8" x 4"
 (279 x 203 x 102 mm)

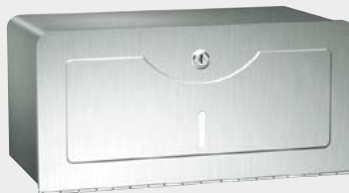

0245-SS
TRADITIONAL™ SURFACE MOUNTED
PAPER TOWEL DISPENSER

400
 SINGLE-FOLD
 PAPER TOWELS

MANUAL
 DISPENSING

Overall Dimensions:
 11¼" x 6¼" x 5⅝"
 (285 x 160 x 143 mm)



1002
TRADITIONAL™ COUNTER TOP MOUNTED
PAPER TOWEL DISPENSER

UP TO 300
 MULTI-FOLD
 PAPER TOWELS

MANUAL
 DISPENSING

COUNTER
 MOUNTED

Unit Size:
 14¼" x 6" x ⅜"
 (362 x 152 x 2 mm)

Counter Opening:
 12½" x 4¼"
 (318 x 108 mm)



1001
TRADITIONAL™ COUNTER TOP MOUNTED
PAPER TOWEL DISPENSER/WASTE RECEPTACLE

UP TO 300
 MULTI-FOLD
 PAPER TOWELS

7.5 gal.
 WASTE CAPACITY
 (28 L)

COUNTER
 MOUNTED

Unit Size:
 14¼" x 15" x ⅜"
 (362 x 381 x 2 mm)

Counter Opening:
 12½" x 13½"
 (318 x 343 mm)



04692A
**TRADITIONAL™ AUTOMATIC
 RECESSED ROLL PAPER
 TOWEL DISPENSER AND
 WASTE RECEPTACLE**

UP TO 800 ft. NO-TOUCH 17 gal.
 (244 M) LONG ROLL DISPENSING WASTE CAPACITY
 TOWEL CAPACITY (64 L)

**SUFFIX OPTIONS FOR POWER/
 MOUNTING:**
[A, A-6, A-9, AC, AC-6, AC-9]

- A:** Powered by 4 D-size batteries (not included).
- AC:** Powered by AC plug-in adapter.
- 6:** Semi-recessed with a stainless steel collar.
- 9:** Surface mounted with a stainless steel collar.
- 04692:** Mechanical lever dispenser.

Unit Size:
 17¼" x 56" x 10¼"
 (438 x 1422 x 260 mm)

Wall Opening:
 15¾" x 54½" x 10"
 (400 x 1384 x 254 mm)



046921A
**TRADITIONAL™ AUTOMATIC
 RECESSED ROLL PAPER
 TOWEL DISPENSER AND
 WASTE RECEPTACLE**

UP TO 800 ft. NO-TOUCH 12 gal.
 (244 M) LONG ROLL DISPENSING WASTE CAPACITY
 TOWEL CAPACITY (45.4 L)

**SUFFIX OPTIONS FOR POWER/
 MOUNTING:**
[A, A-6, A-9, AC, AC-6, AC-9]

- A:** Powered by 4 D-size batteries (not included).
- AC:** Powered by AC plug-in adapter.
- 6:** Semi-recessed with a stainless steel collar.
- 9:** Surface mounted with a stainless steel collar.
- 046921:** Mechanical lever dispenser.

Unit Size:
 17¼" x 56" x 10¼"
 (438 x 1422 x 260 mm)

Wall Opening:
 15¾" x 54½" x 10¼"
 (400 x 1384 x 260 mm)



8523A
**TRADITIONAL™ AUTOMATIC
 SURFACE MOUNTED ROLL PAPER
 TOWEL DISPENSER**

UP TO 800 ft. NO-TOUCH
 (244 M) LONG ROLL DISPENSING
 TOWEL CAPACITY

**SUFFIX OPTIONS FOR POWER/
 MOUNTING:**
[A, AC]

- AC:** Powered by AC plug-in adapter.

Unit Size:
 13" x 17¾" x 10½"
 (330 x 451 x 267 mm)



045210A
TRADITIONAL™ AUTOMATIC
RECESSED ROLL PAPER
TOWEL DISPENSER

UP TO 800 ft. NO-TOUCH
 (244 M) LONG ROLL DISPENSING
 TOWEL CAPACITY

SUFFIX OPTIONS FOR
POWER/MOUNTING:
[A, A-6, A-9, AC, AC-6, AC-9]

- A:** Powered by 4 D-size batteries (not included).
- AC:** Powered by AC plug-in adapter.
- 6:** Semi-recessed with a stainless steel collar.
- 9:** Surface mounted with a stainless steel collar.

Unit Size:
 17¼" x 28" x 10"
 (438 x 711 x 254 mm)

Wall Opening:
 15¾" x 26½" x 10¼"
 (400 x 673 x 260 mm)



046926
TRADITIONAL™ SEMI-RECESSED
SPRING OPERATED NO-TOUCH
ROLL PAPER TOWEL DISPENSER
AND WASTE RECEPTACLE

UP TO 800 ft. NO-TOUCH 12 gal.
 (244 M) LONG ROLL DISPENSING WASTE CAPACITY
 TOWEL CAPACITY (45.4 L)

Unit Size:
 17¼" x 56" x 9¼"
 (438 x 1422 x 235 mm)

Wall Opening:
 15¾" x 54½" x 4"
 (400 x 1384 x 102 mm)



046924
TRADITIONAL™ RECESSED
ROLL PAPER TOWEL DISPENSER
AND WASTE RECEPTACLE

UP TO 800 ft. 12 gal.
 (244 M) LONG ROLL WASTE CAPACITY
 TOWEL CAPACITY (45.4 L)

Model Options:
046924-9 Surface Mounted with a stainless steel collar.

Unit Size:
 17¼" x 56" x 10¼"
 (438 x 1422 x 260 mm)

Wall Opening:
 15¾" x 54½" x 4"
 (400 x 1384 x 102 mm)



8522

TRADITIONAL™ SURFACE MOUNTED ROLL PAPER TOWEL DISPENSER

UP TO 800 ft. (244 M) LONG ROLL TOWEL CAPACITY **MANUAL DISPENSING**

Model Options:

8523A Powered by 4 D-size batteries (not included).

8523AC Powered by AC plug-in adapter.

Overall Dimensions:

14" x 16" x 9½"
(356 x 406 x 241 mm)



8165

TRADITIONAL™ SURFACE MOUNTED ROLL PAPER TOWEL DISPENSER

1 PAPER TOWEL ROLL CAPACITY **MANUAL DISPENSING**

Overall Dimensions:

Unit measures 13" (330 mm) wide; projects 6" (152 mm) from wall.



0828

TRADITIONAL™ SURFACE MOUNTED WASTE RECEPTACLE

6.5 gal. WASTE CAPACITY (24.8 L)

Overall Dimensions:

14" x 18" x 6"
(356 x 457 x 152 mm)



0825

TRADITIONAL™ SURFACE MOUNTED WASTE RECEPTACLE

17 gal. WASTE CAPACITY (64 L)

Model Option:

0826 has 12 gal. (45.4 L) capacity with 15¼" x 23" x 8" (387 x 584 x 203 mm) dimensions.

Overall Dimensions:

15¾" x 21⅞" x 11¼"
(400 x 556 x 298 mm)



0827

TRADITIONAL™ SURFACE MOUNTED WASTE RECEPTACLE

2 gal. WASTE CAPACITY (7.6 L)

Overall Dimensions:

10½" x 9" x 4¾"
(267 x 229 x 121 mm)



1003

TRADITIONAL™ COUNTER TOP MOUNTED WASTE RECEPTACLE

7.4 gal. WASTE CAPACITY (28 L) **COUNTER MOUNTED**

Unit Size:

14¼" x 10" x ⅝"
(362 x 254 x 2 mm)

Counter Opening:

8¾" x 12½"
(222 x 318 mm)



1000
TRADITIONAL™ CIRCULAR
COUNTER TOP WASTE CHUTE

6" COUNTER
DIAMETER MOUNTED

Model Option:
1000A has a 9" (229 mm) outside diameter with a counter opening of 8 1/8" (206 mm) diameter.

Unit Size:
6 3/4" (171 mm)
outside diameter

Counter Opening:
5 3/4" (146 mm)
diameter



0834
TRADITIONAL™ FREESTANDING
WASTE RECEPTACLE

14 gal. FLOOR
WASTE CAPACITY STANDING
(54 L)

Model Option:
0839 has 19 gal. (72 L) capacity with 12 3/8" x 32" x 12 1/2" (314 x 800 x 318 mm) dimensions.

Overall Dimensions:
12 3/8" x 24" x 12 1/2"
(314 x 609 x 318 mm)



0834-T
TRADITIONAL™ FREESTANDING
WASTE RECEPTACLE WITH DUAL
SWING TOP

14 gal. FLOOR
WASTE CAPACITY STANDING
(54 L)

Model Option:
0839-T has 19 gal. (72 L) capacity with 12 3/8" x 37 1/4" x 12 1/2" (314 x 946 x 318 mm) dimensions.

Overall Dimensions:
12 3/8" x 29 3/4" x 12 1/2"
(314 x 756 x 318 mm)



0829
TRADITIONAL™ CORNER
WASTE RECEPTACLE

16 gal. CORNER-SURFACE
WASTE CAPACITY MOUNTED
(60 L)

Overall Dimensions:
15" x 23" x 14 1/2"
(381 x 584 x 368 mm)



0458
TRADITIONAL™ SEMI-RECESSED
WASTE RECEPTACLE

12 gal.
WASTE CAPACITY
(46 L)

Model Option:
0458-9 Surface mounted with a stainless steel collar.

Unit Size:
17 1/4" x 30 1/2" x 8 1/4" (438 x 775 x 210 mm)

Wall Opening:
15 3/4" x 29" x (variable") (400 x 737 mm)
*0458 if 4" (102 mm) x 4" and 12 gals. (46 L);
0458-CX if 1/2" (13 mm) x 7 1/2" (191 mm) and
12 gals. (46 L); 0458-DX if 8" (203 mm) x 4"
(102 mm) and 18 gals. (68 L)



04733
TRADITIONAL™ RECESSED
WASTE RECEPTACLE

3 gal.
WASTE CAPACITY
(11.4 L)

Unit Size:
14 1/4" x 28" x 4 1/2"
(362 x 711 x 114 mm)

Wall Opening:
12 3/4" x 26 1/2" x 4"
(324 x 673 x 102 mm)



MATTE BLACK COLLECTION

The Trending Crossover

The Matte Black Collection — a chic alternative of carefully curated versatility makes a statement in any setting. The boldness of black creates an air of sophistication, while the subtlety of the matte finish exudes warmth.



**PAPER TOWEL
COMBINATION
UNITS**



**SOAP
DISPENSERS**



**BABY
CHANGERS**



0210-41
MATTE BLACK SURFACE MOUNTED PAPER TOWEL DISPENSER

525 MULTI-FOLD **MANUAL**
 OR 400 C-FOLD DISPENSING
 PAPER TOWELS

Overall Dimensions:
 11 1/8" x 14 5/8" x 4"
 (282 x 371 x 101 mm)



6467-41PC
SIMPLICITY™ IN MATTE BLACK RECESSED PAPER TOWEL DISPENSER & WASTE RECEPTACLE

800 MULTI-FOLD **4.2 gal.**
 OR 600 C-FOLD WASTE CAPACITY
 PAPER TOWELS (16 L)

Model Option:
6467-9-41PC Surface mounted with a matte black powder coated stainless steel collar.

Unit Size:
 13" x 55" x 4 3/4"
 (330 x 1397 x 121 mm)

Wall Opening:
 11 1/2" x 53 1/2" x 4"
 (292 x 1359 x 102 mm)



64623-41PC
SIMPLICITY™ IN MATTE BLACK RECESSED PAPER TOWEL DISPENSER AND WASTE RECEPTACLE

475 MULTI-FOLD **2.2 gal.**
 OR 350 C-FOLD WASTE CAPACITY
 PAPER TOWELS (8.4 L)

Model Option:
64623-9-41PC Surface mounted with a matte black powder coated stainless steel collar.

Unit Size:
 14 1/4" x 28" x 4 3/4"
 (362 x 711 x 121 mm)

Wall Opening:
 12 3/4" x 26 1/2" x 4 1/4"
 (324 x 673 x 108 mm)



64672-41PC
SIMPLICITY™ IN MATTE BLACK
RECESSED 3-IN-1 CABINET – PAPER
TOWEL DISPENSER, WASTE
RECEPTACLE, AND HIGH-SPEED
HAND DRYER*

500 MULTI-FOLD
 OR 400 C-FOLD
 PAPER TOWELS

6.8 gal.
 WASTE CAPACITY
 (26 L)

*Hand Dryer sold separately.

Unit Size:
 15⁵/₁₆" x 55³/₁₆" x 7¹/₂"
 (391 x 1407 x 191 mm)

Wall Opening:
 14³/₃₂" x 54³/₁₆" x 7¹/₄"
 (358 x 1381 x 184 mm)



0362-41
AUTOMATIC LIQUID SOAP AND
GEL HAND SANITIZER DISPENSER

28 oz. CAPACITY

NO-TOUCH DISPENSING

BATTERY POWERED

Overall Dimensions:
 4¹³/₁₆" x 10⁵/₁₆" x 4¹/₈"
 (122 x 270 x 105 mm)



0347-41
VERTICAL SOAP DISPENSER

0345-41
HORIZONTAL SOAP DISPENSER

40 oz. CAPACITY

MANUAL DISPENSING

0347 Unit Size:
 4¹/₁₆" x 8³/₁₆" x 3¹⁵/₁₆"
 (122 x 208 x 100 mm)

0345 Unit Size:
 8³/₁₆" x 4¹³/₁₆" x 3¹⁵/₁₆"
 (208 x 122 x 100 mm)

Spout Projection:
 1⁵/₁₆" (24 mm)



9343-41
LIQUID SOAP DISPENSER

48 oz.
CAPACITY

SURFACE
MOUNTED

Overall Dimensions:
7¼" x 6½" x 3⅛"
(184 x 165 x 94 mm)

Spout Projection:
⅞" (24 mm)



0397-1AC-41
EZ FILL™ WATER FAUCET

0394-1AC-41
EZ FILL™ FOAM SOAP DISPENSER

NO-TOUCH
DISPENSING

VANITY
MOUNTED

Complete the look with the matching EZ Fill™ Water Faucet.

See all EZ Fill™ model options on page 59.

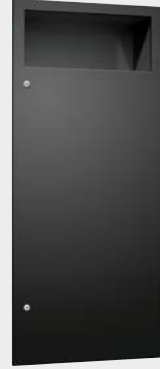

6474-41PC
SIMPLICITY™ IN MATTE BLACK
RECESSED WASTE RECEPTACLE

12 gal.
WASTE CAPACITY
(45.4 L)

Model Option:
6474-2-41PC Semi-recessed with a matte black powder coated stainless steel collar.

Unit Size:
17¼" x 40" x 6¾"
(438 x 1016 x 171 mm)

Wall Opening:
15¾" x 38½" x 6¼"
(400 x 978 x 159 mm)



0196-41
TURBO-PRO™ HIGH-SPEED
ADA HAND DRYER

<15 sec.
DRYING TIME

68-73.8 dBA
NOISE LEVEL

HEPA
FILTER

Voltage: 110-120 V (-1) and
208-240 V (-2)

Overall Dimensions:
8⅞" x 13⅞" x 4"
(219 x 345 x 102 mm)

Noise Level: 68-73.8 dBA



0199-1-41
ASI TURBO-ADA ACCESSIBILITY
COMPLIANT HIGH-SPEED
HAND DRYER

<15 sec.
DRYING TIME

68.9-74.3 dBA
NOISE LEVEL

Overall Dimensions:
10⅞" x 8⅞" x 4"
(270 x 215 x 102 mm)



0600-41
INTER-LOK ANGLE FRAME MIRROR

15 YEAR
WARRANTY

Model Options:
0600-1836-41 – 18" wide x 36" high
(457 x 914 mm)
0600-2436-41 – 24" wide x 36" high
(610 x 914 mm)
0600-2448-41 – 24" wide x 48" high
(610 x 1219 mm)



9014-41
BABY CHANGING STATION, HORIZONTAL –
MATTE BLACK, SURFACE MOUNTED

≤250 lbs.

Overall Dimensions:

Closed: 35⁵/₃₂" x 24¹/₄" x 3⁷/₁₆"
 (893 x 616 x 98 mm) Open: 35⁵/₃₂" x 24¹/₄" x 22¹/₃₂"
 (893 x 616 x 560 mm)



9018-41
BABY CHANGING STATION, HORIZONTAL –
MATTE BLACK, RECESSED

≤250 lbs.

Overall Dimensions:

Closed: 35⁵/₃₂" x 24¹/₄" x 3⁷/₁₆"
 (893 x 616 x 98 mm) Open: 35⁵/₃₂" x 24¹/₄" x 22¹/₃₂"
 (893 x 616 x 560 mm)



0864-41
(30) NAPKIN/ (27) TAMPON VENDOR – MATTE BLACK,
SURFACE MOUNTED – 25¢, 50¢ OR FREE OPERATION

27
 TAMPON
 CAPACITY **30**
 NAPKIN
 CAPACITY

Overall Dimensions:

11-3/4" x 26-1/8" x 6-1/2"
 (298 x 663 x 165 mm)



0839-41
WASTE RECEPTACLE (19 GAL.) –
MATTE BLACK, FREE STANDING

19 gal.
 WASTE CAPACITY
 (72 L) **FLOOR**
 STANDING

Overall Dimensions:

12³/₁₆" x 32" x 12¹/₂"
 (314 x 800 x 318 mm)



0030-41
**MATTE BLACK TOILET TISSUE DISPENSER,
TWIN HIDE-A-ROLL – SURFACE MOUNTED**

2
TOILET PAPER
CAPACITY (ROLLS)

Unit Size:
6" x 12" x 6½"
(152 x 305 x 165 mm)



0042-41
JUMBO ROLL TOILET TISSUE DISPENSER

JUMBO **SURFACE**
TOILET PAPER MOUNTED
CAPACITY (ROLLS)

Overall Dimensions:
4⅝" x 10⅜" x 4¼"
(118 x 262 x 113 mm)



7305-41
SINGLE TOILET TISSUE HOLDER
7305-2-41
DOUBLE TOILET TISSUE HOLDER

SURFACE
MOUNTED

7304-41 Dimensions:
7¾" x 2" x 3⅞"
(207 x 51 x 98 mm)

7305-2-41 Dimensions:
13½" x 2" x 3⅞"
(343 x 51 x 98 mm)



3801-41
STRAIGHT GRAB BAR

Model Options:
3801-18-41 – 18" (457 mm)
3801-24-41 – 24" (610 mm)
3801-36-41 – 36" (914 mm)
3801-42-41 – 42" (1067 mm)



0852-41
SANITARY NAPKIN DISPOSAL –
MATTE BLACK, SURFACE MOUNTED

1.2 gal.
WASTE CAPACITY
(4.5 L)

Overall Dimensions:
7⁷/₈" x 9¹¹/₁₆" x 4"
(200 x 246 x 102 mm)



0477-SM-41
MATTE BLACK SURFACE MOUNTED TOILET
SEAT COVER DISPENSER

250 SINGLE
OR HALF-FOLD
PAPER SEAT
COVERS

Unit Size:
15³/₄" x 11" x 1⁷/₈"
(400 x 279 x 48 mm)



7340-41
SINGLE ROBE HOOK

SURFACE
MOUNTED

Unit Size:
2" x 2" x 2"
(51 x 51 x 51 mm)



7355-24-41
ROUND TOWEL BAR – 24"

ROUND
STYLE

Unit Size:
24" x 2" x 3¹/₄"
(106 x 51 x 83 mm)



7385-41
TOWEL RING

Unit Size:
4¹/₂" x 5" x 2¹/₂"
(114 x 127 x 64 mm)



PAPER TOWEL DISPENSERS

Fundamental variety within a commercial washroom – from recessed, high capacity, and manual to wall mounted, exquisite, and automatic solutions.



**TRADITIONAL™
SURFACE
MOUNTED ROLL
PAPER TOWEL
DISPENSER**



**ROVAL™
RECESSED
PAPER TOWEL
DISPENSER**



**TRADITIONAL™
RECESSED
PAPER TOWEL
DISPENSER**



0210

**TRADITIONAL™ SURFACE MOUNTED
PAPER TOWEL DISPENSER**

525 MULTI-FOLD
OR 400 C-FOLD
PAPER TOWELS

**MANUAL
DISPENSING**

Model Option:
0210-41 Matte black.

Unit Size:
11¹/₁₆" x 14⁵/₁₆" x 4"
(282 x 371 x 101 mm)



20210

**ROVAL™ SURFACE MOUNTED
PAPER TOWEL DISPENSER**

525 MULTI-FOLD
OR 400 C-FOLD
PAPER TOWELS

**MANUAL
DISPENSING**

Overall Dimensions:
11¹/₁₆" x 13⁹/₁₆" x 4⁷/₈"
(281 x 345 x 124 mm)



6457

SIMPLICITY™ RECESSED PAPER TOWEL DISPENSER

475 MULTI-FOLD
OR 350 C-FOLD
PAPER TOWELS

**MANUAL
DISPENSING**

Unit Size:
12³/₄" x 17¹/₄" x 4¹/₂"
(324 x 438 x 114 mm)

Wall Opening:
11¹/₄" x 15³/₄" x 4¹/₄"
(286 x 400 x 108 mm)



6452

SIMPLICITY™ RECESSED PAPER TOWEL DISPENSER

800 MULTI-FOLD
OR 600 C-FOLD
PAPER TOWELS

**MANUAL
DISPENSING**

Model Option:
6452-9 Surface mounted with a stainless steel collar.

Unit Size:
14¹/₄" x 28" x 4¹/₂"
(362 x 711 x 114 mm)

Wall Opening:
12³/₄" x 26¹/₂" x 4¹/₄"
(324 x 673 x 108 mm)

PAPER TOWEL DISPENSERS



0457
TRADITIONAL™ RECESSED PAPER TOWEL DISPENSER

500 MULTI-FOLD
OR 350 C-FOLD
PAPER TOWELS

MANUAL
DISPENSING

Model Options:
0457-2 Semi-recessed.
0457-9 Surface mounted with a stainless steel collar.

Unit Size:
12³/₄" x 17¹/₄" x 4¹/₄"
(324 x 438 x 108 mm)

Wall Opening:
11¹/₄" x 15³/₄" x 4"
(286 x 400 x 102 mm)



0452
TRADITIONAL™ RECESSED PAPER TOWEL DISPENSER

800 MULTI-FOLD
OR 600 C-FOLD
PAPER TOWELS

MANUAL
DISPENSING

Model Option:
0452-9 Surface mounted with a stainless steel collar.

Unit Size:
14¹/₄" x 28" x 4¹/₄"
(326 x 711 x 108 mm)

Wall Opening:
12³/₄" x 26¹/₂" x 4"
(324 x 673 x 102 mm)



6457-00
PIATTO™ COMPLETELY RECESSED PAPER TOWEL DISPENSER

475 MULTI-FOLD
OR 350 C-FOLD
PAPER TOWELS

MANUAL
DISPENSING

Model Option:
6457-41 Matte Black.

Unit Size:
12³/₄" x 17¹/₄" x 4⁹/₁₆"
(324 x 438 x 116 mm)

Wall Opening:
12¹³/₁₆" x 17⁹/₁₆" x 4³/₄"
(325 x 440 x 121 mm)



645210AC-41
PIATTO™ COMPLETELY RECESSED AUTOMATIC ROLL PAPER TOWEL DISPENSER

UP TO 800 ft.
(244 M) LONG ROLL
TOWEL CAPACITY

NO-TOUCH
DISPENSING

Model Option:
645210AC-00 White.

Unit Size:
16¹/₁₆" x 28" x 9¹³/₁₆"
(408 x 711 x 248 mm)

Wall Opening:
16¹/₁₆" x 28¹/₁₆" x 10"
(410 x 713 x 254 mm)



645210A-41

PIATTO™ COMPLETELY RECESSED AUTOMATIC ROLL PAPER TOWEL DISPENSER

UP TO 800 ft.
(244 M) LONG ROLL
TOWEL CAPACITY

NO-TOUCH
DISPENSING

Model Option:
645210A-00 White.

Unit Size:
16¹/₁₆" x 28" x 9¹³/₁₆"
(408 x 711 x 248 mm)

Wall Opening:
16¹/₈" x 28¹/₁₆" x 10"
(410 x 713 x 254 mm)



20452

ROVAL™ RECESSED PAPER TOWEL DISPENSER

800 MULTI-FOLD
OR 600 C-FOLD
PAPER TOWELS

MANUAL
DISPENSING

Overall Dimensions:
12³/₄" x 28" x 5⁷/₁₆"
(324 x 711 x 137 mm)

Wall Opening:
11¹/₄" x 26⁷/₁₆" x 3¹⁵/₁₆"
(286 x 672 x 100 mm)



68523A

SIMPLICITY™ AUTOMATIC ROLL TOWEL DISPENSER

UP TO 800 ft.
(244 M) LONG ROLL
TOWEL CAPACITY

NO-TOUCH
DISPENSING

SUFFIX OPTIONS FOR POWER/MOUNTING:
[A, A-4, AC, AC-4]

A: Powered by 4 D-size batteries (not included).
AC: Powered by AC plug-in adapter.
-4: Semi-recessed stainless steel.

Overall Dimensions:
15¹/₄" x 18⁵/₁₆" x 9¹³/₁₆"
(387 x 465 x 249 mm)



645210A

SIMPLICITY™ AUTOMATIC ROLL PAPER TOWEL DISPENSER

UP TO 800 ft.
(244 M) LONG ROLL
TOWEL CAPACITY

NO-TOUCH
DISPENSING

SUFFIX OPTIONS FOR POWER/MOUNTING:
[A, A-6, A-9, AC, AC-6, AC-9]

A: Powered by 4 D-size batteries (not included).
AC: Powered by AC plug-in adapter.
-6: Semi-recessed with a stainless steel collar.
-9: Surface mounted with a stainless steel collar.

Unit Size:
16¹/₁₆" x 28" x 9¹/₂"
(408 x 711 x 241 mm)

Wall Opening:
14¹/₂" x 26¹/₂" x 9¹/₄"
(368 x 673 x 235 mm)



645224A

SIMPLICITY™ AUTOMATIC ROLL PAPER TOWEL DISPENSER

UP TO 800 ft.
(244 M) LONG ROLL
TOWEL CAPACITY

NO-TOUCH
DISPENSING

SUFFIX OPTIONS FOR POWER/MOUNTING:
[A, A-6, AC, AC-6, AC-9]

AC: Powered by AC plug-in adapter.
-9: Surface mounted with a stainless steel collar.

Unit Size:
17¼" x 30½" x 10¼"
(438 x 775 x 260 mm)

Wall Opening:
15¾" x 29" x 4"
(400 x 737 x 102 mm)



8524

SPRING LOADED NO-TOUCH SURFACE MOUNTED ROLL PAPER TOWEL DISPENSER

UP TO 800 ft.
(244 M) LONG ROLL
TOWEL CAPACITY

NO-TOUCH
DISPENSING

Model Options:

8523A Auto roll towel dispenser, surface mounted.
8523AC Auto roll towel dispenser, 110-240 VAC, surface mounted.

Unit Size:
12" x 16" x 9"
(305 x 406 x 228 mm)



045210A

TRADITIONAL™ AUTOMATIC RECESSED ROLL PAPER TOWEL DISPENSER

UP TO 800 ft.
(244 M) LONG ROLL
TOWEL CAPACITY

NO-TOUCH
DISPENSING

SUFFIX OPTIONS FOR POWER/MOUNTING:
[A, A-6, A-9, AC, AC-6, AC-9]

A: Powered by 4 D-size batteries (not included).
AC: Powered by AC plug-in adapter.
-6: Semi-recessed with a stainless steel collar.
-9: Surface mounted with a stainless steel collar.

Unit Size:
17¼" x 28" x 10"
(438 x 711 x 254 mm)

Wall Opening:
15¾" x 26½" x 10¼"
(400 x 673 x 260 mm)



204523A

ROVAL™ AUTOMATIC RECESSED ROLL PAPER TOWEL DISPENSER

UP TO 800 ft.
(244 M) LONG ROLL
TOWEL CAPACITY

NO-TOUCH
DISPENSING

SUFFIX OPTIONS FOR POWER/MOUNTING:
[A, A-6, A-9, AC, AC-6, AC-9]

A: Powered by 4 D-size batteries (not included).
AC: Powered by AC plug-in adapter.
-6: Semi-recessed with a stainless steel collar.
-9: Surface mounted with a stainless steel collar.

Unit Size:
17⅜" x 27¾" x 11⅛"
(441 x 705 x 297 mm)

Wall Opening:
15¾" x 26" x 10"
(400 x 660 x 254 mm)



1005
VANITY TOP PAPER TOWEL HOLDER

350 MULTI-FOLD
 OR 250 C-FOLD
 PAPER TOWELS

MANUAL
 DISPENSING

COUNTER
 POSITIONED

Overall Dimensions:
 11" x 7½" x 5½"
 (279 x 191 x 140 mm)

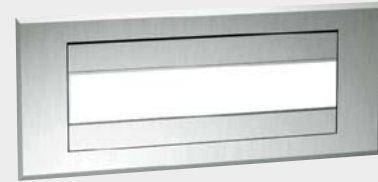

1002
**TRADITIONAL™ COUNTER TOP MOUNTED
 PAPER TOWEL DISPENSER**

UP TO 300
 MULTI-FOLD
 PAPER TOWELS

MANUAL
 DISPENSING

COUNTER
 MOUNTED

Unit Size:
 14¼" x 6" x ¾"
 (362 x 152 x 2 mm)

Counter Opening:
 12½" x 4¼"
 (318 x 108 mm)



0215
**TRADITIONAL™ SURFACE MOUNTED
 PAPER TOWEL DISPENSER – PETITE**

275 MULTI-FOLD
 OR 200 C-FOLD
 PAPER TOWELS

MANUAL
 DISPENSING

Overall Dimensions:
 11" x 8" x 4"
 (279 x 203 x 102 mm)



0245-SS
**TRADITIONAL™ SURFACE MOUNTED
 PAPER TOWEL DISPENSER**

400
 SINGLE-FOLD
 PAPER TOWELS

MANUAL
 DISPENSING

Overall Dimensions:
 11¼" x 6¼" x 5⅝"
 (285 x 160 x 143 mm)



0439

TRADITIONAL™ PAPER TOWEL DISPENSER FOR BEHIND THE MIRROR

800 MULTI-FOLD
OR 600 C-FOLD
PAPER TOWELS

MANUAL
DISPENSING

FOR BEHIND
THE MIRROR

Overall Dimensions:
11½" x 18" x 4½"
(292 x 457 x 108 mm)



8522

TRADITIONAL™ SURFACE MOUNTED ROLL PAPER TOWEL DISPENSER

UP TO 800 ft.
(244 M) LONG ROLL
TOWEL CAPACITY

MANUAL
DISPENSING

Model Options:
8523A Powered by 4 D-size batteries (not included).
8523AC Powered by AC plug-in adapter.

Overall Dimensions:
14" x 16" x 9½"
(356 x 406 x 241 mm)



8165

TRADITIONAL™ SURFACE MOUNTED ROLL PAPER TOWEL DISPENSER

1
PAPER TOWEL
ROLL CAPACITY

MANUAL
DISPENSING

Overall Dimensions:
Unit measures 13" (330 mm) wide;
projects 6" (152 mm) from wall.



8374

AUTOMATIC ROLL TOWEL DISPENSER MECHANISM

UP TO 800 ft.
(244 M) LONG ROLL
TOWEL CAPACITY

NO-TOUCH
DISPENSING

SPARE
PART

Model Option:
8370 Manual lever operated.

Overall Dimensions:
12⁵/₁₆" x 15¹/₁₆" x 8¹¹/₁₆"
(313 x 383 x 221 mm)



PIC SHOWS MODEL 0391



PIC SHOWS MODEL 0334-S

SOAP DISPENSING SYSTEMS SOLUTIONS DETAIL



A VARIETY OF DESIGNS FOR SOAP, FOAM, AND SANITIZER.

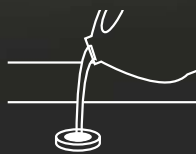

12 DISPENSERS — SINGLE REFILL

Single Soap Reservoir of 1.5gal/6L serves up to 12 soap- or foam-dispensers via convenient Top-Fill-Port in the counter.









UNIVERSAL REMOTE

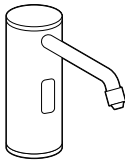
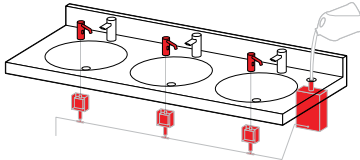









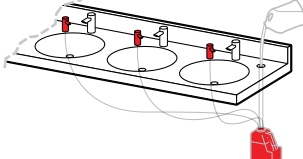

Controls all dispensers with one remote, allowing flexibility in settings with a choice of 4 presets.





SOAP, FOAM, AND SANITIZER DISPENSERS + MATCHING FAUCETS

TOP FILL MULTI-FEED SOAP DISPENSING SYSTEM

0388 & 0389 TOP FILL MULTI-FEED SYSTEM (UP TO 12*)					
					
Soap Heads	Model		Soap Heads	Model	
 LIQUID	0387	Top Fill, Multi-Feed – Vanity Mounted Fill Port w/ 6L Under Vanity Tank	 FOAM	0387	Top Fill, Multi-Feed – Vanity Mounted Fill Port w/ 6L Under Vanity Tank
	 0388-1A	Top Fill, Multi-Feed Liquid Soap Dispenser (Batt. not incl.) Satin Finish		 0389-1A	Top Fill, Multi-Feed Foam Soap Dispenser (Batt. not incl.) Satin Finish
	 0388-1AC	Top Fill, Multi-Feed Liquid Soap Dispenser (AC) Satin Finish		 0389-1AC	Top Fill, Multi-Feed Foam Soap Dispenser (AC) Satin Finish

*Max 6 dispensers on each side of tank. For proper installation refer to owner's manual.

EZ FILL™ INDIVIDUAL					EZ FILL™ MULTI-FEED SYSTEM (UP TO 6)				
					Refill up to six soap dispensers with one pour.				
Individual vanity mounted automatic soap dispenser is refilled by removing 1 liter bottle from EZ FILL™ bracket under the counter.									
Soap Heads	Individual Chrome	6 Pack SKU ¹	Individual Matte Black	6 Pack SKU ¹	Soap Heads	Multi-Feed Chrome	6 Pack SKU ¹	Multi-Feed Matte Black	6 Pack SKU ¹
 LIQUID	 0391-1AC	0391-6-1AC	0391-1AC-41	0391-6-1AC-41	 LIQUID	 0390-1AC	0390-6-1AC	0390-1AC-41	0390-6-1AC-41
	 0391-1A	0391-6-1A	0391-1A-41	0391-6-1A-41		 0390-1A	0390-6-1A	0390-1A-41	0390-6-1A-41
 FOAM	 0394-1AC	0394-6-1AC	0394-1AC-41	0394-6-1AC-41	 FOAM	 0393-1AC	0393-6-1AC	0393-1AC-41	0393-6-1AC-41
	 0394-1A	0394-6-1A	0394-1A-41	0394-6-1A-41		 0393-1A	0393-6-1A	0393-1A-41	0393-6-1A-41

Faucets	
CHROME	 0397-1AC
	 0397-1A
MATTE BLACK	 0397-1AC-41
	 0397-1A-41

TOP FILL, MULTI-FEED SYSTEM REQUIRES (A) AND (B)

(A) 0390 - Multi-Feed Kit² – Kit² includes a 6 Liter Soap Container, Top Fill Tube and Counter Fill Port with Cover (B) Multi-Feed – Soap Dispenser Head(s)⁴

EZ FILL™ ACCESSORIES

0390-BR- Optional Under Counter Mounting Bracket for 6 Liter Container
0390-R- Remote Control¹ to adjust liquid dispensing settings

0390-ARK- Anti-Rotation Kit for all 0390 Series
0393-R- Remote Control¹ to adjust foam dispensing settings

Stand Alone Dispensers come standard with 1 Liter soap container

¹ One Remote Control provided at no charge, with the 6 Pack SKU
² Powered by 6 D-size batteries (not included)

³ Kit does not include soap dispenser heads
⁴ Soap Dispenser Heads do not come with Multi-Feed Kit



0391-(N)
**AUTOMATIC VANITY MOUNTED LIQUID SOAP AND
 GEL HAND SANITIZER DISPENSER – CHROME**

33.8 oz. **NO-TOUCH** **BATTERY**
 CAPACITY DISPENSING POWERED

Model Options:
 0391-(N)-41 Matte Black.
 0390-(N) Multi-Feed Soap Dispenser.
 0393-(N) Multi-Feed Foam Soap Dispenser.
 0394-(N) Stand-Alone Foam Soap Dispenser.

SUFFIX OPTIONS FOR POWER:
 [1A, 1AC, 6-1A, 6-1AC]

1A: Powered by 6 D-size batteries (not included).
 1AC: Powered by AC plug-in adapter.
 6-1A: Powered by 6 D-size batteries (not included).
 6-1AC: Powered by AC plug-in adapter.



0397
EZ FILL™ WATER FAUCET – CHROME

202.8 oz. **NO-TOUCH**
 CAPACITY DISPENSING

Model Option:
 0397-1AC-41 Matte Black.

SUFFIX OPTIONS FOR POWER:
 [1A, 1A-41, 1AC, 1AC-41]

1A: Chrome, battery powered.
 1A-41: Matte Black, battery powered.
 1AC: Chrome, AC powered.
 1AC-41: Matte Black, AC powered.

0390 EZ FILL™
TOP FILL MULTI-FEED KIT
FOR 0390-(N) & 0393-(N)

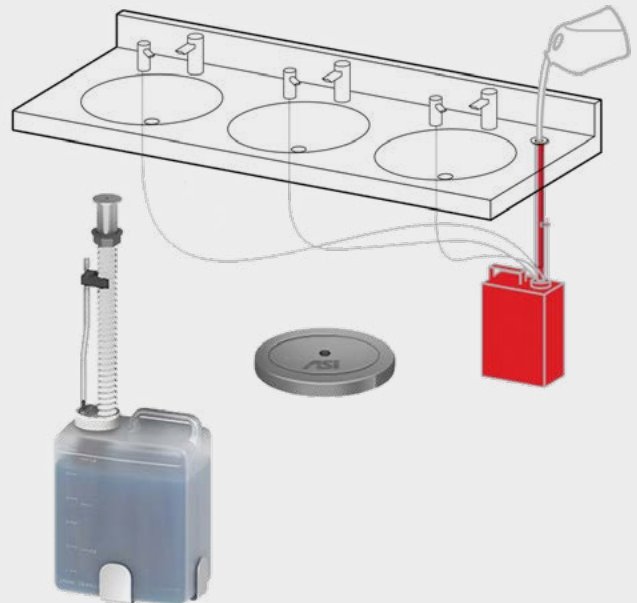



0334-S
**AUTOMATIC VANITY MOUNTED LIQUID SOAP AND
 GEL HAND SANITIZER DISPENSER – SATIN FINISH**

50.7 oz. **NO-TOUCH** **BATTERY**
 CAPACITY DISPENSING POWERED

Model Option:
0334-B Stainless steel with bright finish.

Unit Size:
 1½" x 3¼" (38 x 97 mm)
 (dispenser body only)

Spout Projection:
 3⁄8" (98 mm)



0335-B
**AUTOMATIC VANITY MOUNTED FOAM SOAP AND
 HAND SANITIZER DISPENSER – BRIGHT POLISHED FINISH**

50.7 oz. **NO-TOUCH** **BATTERY**
 CAPACITY DISPENSING POWERED

Model Option:
0335-S Stainless steel with satin finish.

Unit Size:
 1½" x 3¼" (38 x 97 mm)
 (dispenser body only)

Spout Projection:
 3⁄8" (98 mm)

0387
**TOP FILL PORT WITH MULTI-FEED TANK
 FOR 0388 & 0389**

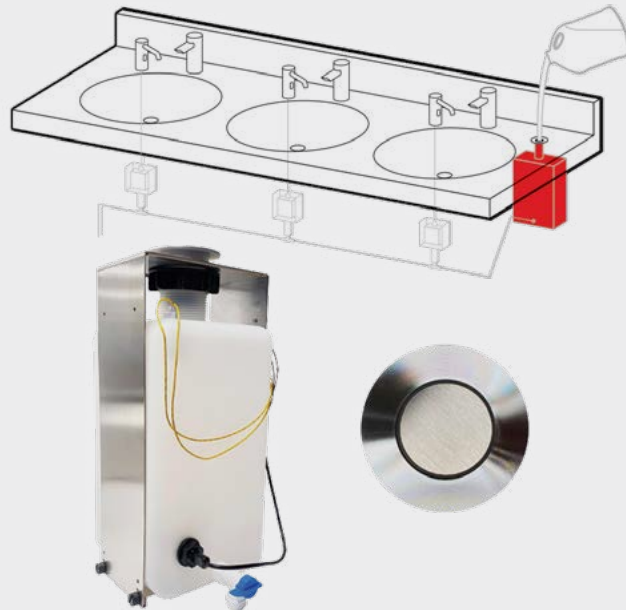



0362-41
AUTOMATIC SURFACE MOUNTED LIQUID SOAP AND GEL HAND SANITIZER DISPENSER – MATTE BLACK

28 oz.
CAPACITY

NO-TOUCH
DISPENSING

BATTERY
POWERED

Model Option:
0362 Satin.

Overall Dimensions:
 4¹³/₁₆" x 10⁵/₁₆" x 4¹/₈"
 (122 x 270 x 105 mm)



0360
AUTOMATIC SURFACE MOUNTED LIQUID SOAP AND GEL HAND SANITIZER DISPENSER

35 oz.
CAPACITY

NO-TOUCH
DISPENSING

BATTERY
POWERED

Overall Dimensions:
 4¹⁷/₃₂" x 9¹/₄" x 4⁷/₈"
 (115 x 235 x 124 mm)



20364
ROVAL™ AUTOMATIC SURFACE MOUNTED LIQUID SOAP AND GEL HAND SANITIZER DISPENSER

34 oz.
CAPACITY

NO-TOUCH
DISPENSING

Model Options:
20363 Liquid soap dispenser.
20365 Foam soap and hand sanitizer.

Overall Dimensions:
 5¹/₂" x 10⁷/₈" x 4"
 (140 x 276 x 102 mm)



0361
AUTOMATIC SURFACE MOUNTED LIQUID SOAP AND GEL HAND SANITIZER DISPENSER

27 oz.
CAPACITY

BATTERY
POWERED

NO-TOUCH
DISPENSING

Overall Dimensions:
 4⁵/₈" x 10⁹/₁₆" x 4¹/₁₆"
 (118 x 262 x 113 mm)

= LIQUID = FOAM

Products with this icon can dispense hand sanitizer.



0338
TOP FILL AUTOMATIC VANITY MOUNTED LIQUID SOAP DISPENSER

50.7 oz. **NO-TOUCH** **VANITY**
CAPACITY DISPENSING MOUNTED

Model Option:
0339 Foam soap dispenser.

Unit Size:
1½" x 5¾" (38 x 137 mm)
(dispenser body only)

Spout Projection:
3¾" (98 mm)



20334
AUTOMATIC VANITY MOUNTED FOAM SOAP DISPENSER

54 oz. **CHROME** **NO-TOUCH** **VANITY**
CAPACITY PLATED BRASS DISPENSING MOUNTED

Model Option:
20333 Liquid soap dispenser.

Overall Dimensions:
6¾" x 16"
(172 x 407 mm)

Spout Projection:
3¾" (99 mm)



0332
VANITY MOUNTED MANUAL LIQUID SOAP DISPENSER

34 oz. **CHROME** **MANUAL** **VANITY**
CAPACITY PLATED BRASS DISPENSING MOUNTED

Model Options:

	Capacity	Spout
0332	34 oz. (1.0 L)	4" (102 mm)
0332-C	20 oz. (0.6 L)	4" (102 mm)
0332-CD	20 oz. (0.6 L)	6" (152 mm)
0332-D	34 oz. (1.0 L)	6" (152 mm)

Unit Size:
3⅞" x 10²/₃₂"
(87 x 271 mm)



0336
VANITY MOUNTED MANUAL FOAM SOAP DISPENSER

34 oz. **MANUAL** **VANITY**
CAPACITY DISPENSING MOUNTED

Unit Size:
3½" x 15¾"
(87 x 271 mm)

Spout Projection:
4" (102 mm)



5001-SS
DISPOSA-VALVE SURFACE MOUNTED
LIQUID SOAP DISPENSER

MANUAL
DISPENSING

Overall Dimensions:
4¼" x 11" x 4"
(108 x 279 x 102 mm)



0341
SURFACE MOUNTED PLASTIC LIQUID AND
ANTISEPTIC SOAP DISPENSER

40.5 oz. **MANUAL**
CAPACITY DISPENSING

Overall Dimensions:
5⅞" x 9⅝" x 4½"
(138 x 233 x 102 mm)



0326
RECESSED HORIZONTAL LIQUID SOAP DISPENSER

57 oz.
CAPACITY

Unit Size:
10¼" x 6" x 4½"
(260 x 152 x 115 mm)

Wall Opening:
9" x 4⅞" x 4"
(229 x 124 x 102 mm)

Spout Projection:
2½" (64 mm)



9343
PROFILE™ SURFACE MOUNTED LIQUID SOAP DISPENSER

48 oz.
CAPACITY

Model Option:
9343-41 Matte Black.

Overall Dimensions:
7¼" x 6½" x 3⅛"
(184 x 165 x 94 mm)

Spout Projection:
1⅝" (24 mm)

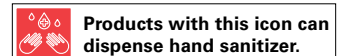



0347
SURFACED MOUNTED VERTICAL
LIQUID SOAP DISPENSER

0345
SURFACED MOUNTED HORIZONTAL
LIQUID SOAP DISPENSER

40 OZ.
CAPACITY **MANUAL**
DISPENSING

Model Options:
0347-41 Matte Black.
0345-41 Matte Black.

0347 Unit Size:
4¹³/₁₆" x 8⁷/₁₆" x 3¹⁵/₁₆"
(122 x 208 x 100 mm)

0345 Unit Size:
8³/₁₆" x 4¹³/₁₆" x 3¹⁵/₁₆"
(208 x 122 x 100 mm)

Spout Projection:
1¹/₂" (38 mm)



0357
SURFACED MOUNTED
HORIZONTAL FOAM SOAP DISPENSER

0359
SURFACED MOUNTED VERTICAL
FOAM SOAP DISPENSER

40 OZ.
CAPACITY **MANUAL**
DISPENSING

0357 Unit Size:
8³/₁₆" x 4¹³/₁₆" x 4¹/₂"
(208 x 122 x 114 mm)

0359 Unit Size:
4¹³/₁₆" x 8³/₁₆" x 4¹/₂"
(122 x 208 x 114 mm)

Spout Projection:
1¹/₂" (38 mm)



WASTE RECEPTACLES

A wide range of waste receptacles, from fully recessed, semi-recessed, surface mounted, and counter mounted to freestanding with fully removable waste cans.

WASTE RECEPTACLES
ALL STAINLESS STEEL IS TYPE 304 WITH SATIN FINISH,
UNLESS OTHERWISE NOTED.



**COVERED
WASTE
RECEPTACLES**



**COUNTER
TOP
WASTE
RECEPTACLES**



**RECESSED
WASTE
RECEPTACLES**



1000
TRADITIONAL™ CIRCULAR
COUNTER TOP WASTE CHUTE

6" COUNTER
DIAMETER MOUNTED

Model Option:
1000A has a 9" (229 mm) outside diameter with a counter opening of 8 1/8" (206 mm) diameter.

Unit Size:
6 3/4" (171 mm)
outside diameter

Counter Opening:
5 3/4" (146 mm) diameter



1003
TRADITIONAL™ COUNTER TOP
MOUNTED WASTE RECEPTACLE

7.4 gal. COUNTER
WASTE CAPACITY MOUNTED
(28 L)

Unit Size:
14 1/4" x 10" x 3/32"
(362 x 254 x 2 mm)

Counter Opening:
8 3/4" x 12 1/2"
(222 x 318 mm)



0815
FLOOR STANDING FOOT
OPERATED WASTE RECEPTACLE

8 gal.
WASTE CAPACITY
(30.7 L)

Overall Dimensions:
10 3/4" x 20 15/16" x 10"
(273 x 531 x 254 mm)



0834-RB
FREESTANDING 3-BIN
RECYCLING STATION

42 gal.
WASTE CAPACITY
(159 L)

Model Option:
0839-RB has 57 gal. (216 L) capacity with 37 1/8" x 31 7/8" x 12 1/2" (943 x 810 x 318 mm).

Overall Dimensions:
37 1/8" x 31 7/8" x 12 1/2"
(943 x 810 x 318 mm)



0834
TRADITIONAL™ FREESTANDING
WASTE RECEPTACLE

14 gal.
WASTE CAPACITY
(54 L)

Model Option:
0839 has 19 gal. (72 L) capacity with 12 3/8" x 32" x 12 1/2" (314 x 800 x 318 mm) dimensions.

Overall Dimensions:
12 3/8" x 24" x 12 1/2"
(314 x 609 x 318 mm)



0834-T
TRADITIONAL™ FREESTANDING
WASTE RECEPTACLE WITH DUAL
SWING TOP

14 gal.
WASTE CAPACITY
(54 L)

Model Option:
0839-T has 19 gal. (72 L) capacity with 12 3/8" x 37 1/4" x 12 1/2" (314 x 946 x 318 mm) dimensions.

Overall Dimensions:
12 3/8" x 29 3/4" x 12 1/2"
(314 x 756 x 318 mm)



0458
TRADITIONAL™ SEMI-RECESSED WASTE RECEPTACLE

12 gal.

WASTE CAPACITY
(46 L)

Model Option:
0458-9 Surface mounted with a stainless steel collar.

Unit Size:

17¼" x 30½" x 8¼"
(438 x 775 x 210 mm)

Wall Opening:

15¼" x 29" x (variable*)
(400 x 737 mm)

*[0458 if 4" (102 mm) x 4" and 12 gals. (46 L); 0458-CX if ½" (13 mm) x 7½" (191 mm) and 12 gals. (46 L); 0458-DX if 8" (203 mm) x 4" (102 mm) and 18 gals. (68 L)]



7317
COVERED WASTE RECEPTACLE – BRIGHT POLISHED FINISH

2.0 gal.

WASTE CAPACITY
(7.6 L)

FLOOR

STANDING

Model Option:
7317-S Satin stainless steel finish.

Overall Dimensions:

8½" DIA x 12¾"
(210 DIA x 324 mm)



0829
CORNER WASTE RECEPTACLE

16 gal.

WASTE CAPACITY
(60 L)

CORNER-SURFACE MOUNTED

Overall Dimensions:

15" x 23" x 14½"
(381 x 584 x 368 mm)



20826
ROVAL™ SURFACE MOUNTED WASTE RECEPTACLE

12.8 gal.

WASTE CAPACITY
(48.4 L)

Model Option:
20826-T Closed top, spring-loaded door. Capacity 12.8 gal. (48.4 L).

Overall Dimensions:

15⅝" x 23" x 8½"
(384 x 584 x 216 mm)



20458
**ROVAL™ SEMI-RECESSED REMOVABLE
WASTE RECEPTACLE**

11.2 gal.

WASTE CAPACITY
(42.6 L)

Unit Size:
17⁵/₈" x 27³/₄" x 8¹⁵/₁₆"
(441 x 705 x 227 mm)

Wall Opening:
15³/₄" x 26" x 3¹⁵/₁₆"
(400 x 660 x 100 mm)



0825
TRADITIONAL™ SURFACE MOUNTED WASTE RECEPTACLE

17 gal.

WASTE CAPACITY
(64 L)

Model Option:
0826 has 12 gal. (45.4 L) capacity with
15¹/₄" x 23" x 8" (387 x 584 x 203 mm) dimensions.

Overall Dimensions:
15³/₄" x 21¹/₂" x 11³/₄"
(400 x 556 x 298 mm)



0827
**TRADITIONAL™ SURFACE MOUNTED
WASTE RECEPTACLE**

2 gal.

WASTE CAPACITY
(7.6 L)

Overall Dimensions:
10¹/₂" x 9" x 4³/₄"
(267 x 229 x 121 mm)



0828
**TRADITIONAL™ SURFACE MOUNTED
WASTE RECEPTACLE**

6.5 gal.

WASTE CAPACITY
(24.8 L)

Overall Dimensions:
14" x 18" x 6"
(356 x 457 x 152 mm)



6474

SIMPLICITY™ RECESSED WASTE RECEPTACLE

12 gal.

WASTE CAPACITY
(45.4 L)

Model Options:

- 6474-41PC** Matte Black
- 6474-2** Semi-recessed with a stainless steel collar.
- 6474-2-41PC** Matte Black.

Unit Size:

17¼" x 40" x 6¾"
(438 x 1016 x 171 mm)

Wall Opening:

15¾" x 38½" x 6¼"
(400 x 978 x 159 mm)



6474-00

PIATTO™ RECESSED WASTE RECEPTACLE

12 gal.

WASTE CAPACITY
(46 L)

CONCEALED

LOCKING MECHANISM

Unit Size:

17¼" x 40" x 6⅞"
(438 x 1016 x 166 mm)

Finished Wall Opening*:

17⅞" x 40⅞" x 6⅞"
(440 x 1018 x 170 mm)



04733

TRADITIONAL™ RECESSED WASTE RECEPTACLE

3 gal.

WASTE CAPACITY
(11.4 L)

Unit Size:

14¼" x 28" x 4½"
(362 x 711 x 114 mm)

Wall Opening:

12¾" x 26½" x 4"
(324 x 673 x 102 mm)



6459

SIMPLICITY™ RECESSED WASTE RECEPTACLE

4 gal.

WASTE CAPACITY
(15.0 L)

Unit Size:

14¼" x 28" x 4½"
(362 x 711 x 114 mm)

Wall Opening:

12¾" x 26½" x 4¼"
(324 x 673 x 108 mm)



TURBO-PRO™ DETAILS

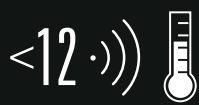

ADJUSTABLE AND FAST

Speed, noise, and temperature are adjustable.

HEPA

FILTER

HEPA FILTER

A HEPA filter is used to purify the air before it dries hands.

16

GAUGE

STAINLESS STEEL CONSTRUCTION

Our hand dryers are constructed of stainless steel, which is tough, durable, stain-resistant, and easy to clean.



ADA ACCESSIBILITY STANDARD COMPLIANT

Our hand dryers are engineered to comply with the standards set forth by the Americans with Disabilities Act for accessibility and safety.

AUTOMATIC HAND DRYERS

Elegant and functional dryer range—from HEPA filtered High Speed Models (less than 10 sec.) to very quiet Icons (less than 66 dBA)—most of them with adjustable settings (air-speed and temperature).

FEATURES

- Fast drying
- Quiet
- Ultra-hygienic – HEPA filter
- ADA compliant – ultra slim

VARIABLE SETTINGS

- Noise (Airflow)
- Heat
- Energy Efficiency

NOISE LEVEL

68 to 73.8 dBA

DIMENSIONS

8⁵/₈" x 13³/₁₆" x 4"
(219 x 345 x 102 mm)

ELECTRIC

Different models for operating voltage

110-120 V (50/60 Hz),

220-240 V (50/60 Hz)

ON/OFF Heat Option

Nichrome Wire

325 – 500 W



0192-1-93
TURBO SWIFT™ ADA HIGH-SPEED HAND DRYER

<12 sec.
DRYING TIME

74 dBA
NOISE LEVEL

Voltage: 110-120 V

Model Option:
0192-1-41 Matte Black.
0192-2-93 Satin Stainless Steel.

Overall Dimensions:
6²⁷/₃₂" x 10¹/₁₆" x 4"
(174 x 256 x 102 mm)



0196-1-41
TURBO-PRO™ HIGH-SPEED ADA HAND DRYER

<15 sec.
DRYING TIME

68-73.8 dBA
NOISE LEVEL

HEPA
FILTER

Voltage: 110-120 V (-1) and 208-240 V (-2)

Model Option:
0196-1-00 White.
0196-1-93 Satin Stainless Steel.
0196-2-00 White.
0196-2-41 Matte Black.
0196-2-93 Satin Stainless Steel.

Overall Dimensions:
8⁵/₈" x 13³/₁₆" x 4"
(219 x 345 x 102 mm)



0197-1
TURBO-DRI™ HIGH-SPEED HAND DRYER

<15 sec.
DRYING TIME

61.2-65.2 dBA
NOISE LEVEL

Voltage: 115-120 V (-1) and 208-240 V (-2)
Auto Shut Off: 60 seconds

Model Option:
0197-2-93 Satin Stainless Steel.

Overall Dimensions:
8¹/₁₆" x 11¹³/₆₄" x 7⁵/₆₄"
(205 x 287 x 180 mm)



0199-1-41
**ASITURBO-ADA ACCESSIBILITY COMPLIANT
HIGH-SPEED HAND DRYER**

<15 sec.
DRYING TIME

68.9-74.3 dBA
NOISE LEVEL

Voltage: 110-120 V (-1) and 208-240 V (-2)
Auto Shut Off: 60 seconds

Model Option:
0199-1-00 White.
0199-1-93 Satin Stainless Steel.
0199-2-00 White.
0199-2-41 Matte Black.
0199-2-93 Satin Stainless Steel.

Overall Dimensions:
10⁵/₈" x 8¹⁵/₃₂" x 4"
(270 x 215 x 102 mm)





0185
PROFILE™ HAND DRYER

<25 sec.
DRYING TIME

69.2 dBA
NOISE LEVEL

Voltage: Automatically adjusts to voltages of 100-240 V

Model Option:

- 0184** Surface mounted no-touch hand dryer, 277 V.
- 0185-92** Bright Stainless Steel.
- 0185-00** White.
- 0185-93** Satin Stainless Steel.

Overall Dimensions:

14⁷/₁₆" x 10¹³/₁₆" x 3¹⁵/₁₆"
(367 x 275 x 100 mm)



20199
ROVAL™ SEMI-RECESSED HIGH-SPEED HAND DRYER

<15 sec.
DRYING TIME

69 dBA
NOISE LEVEL

Voltage: 120 V (-1) and 240 V (-2)

Unit Size:

11" x 15¹/₂" x 5²³/₃₂"
(279 x 394 x 145 mm)

Wall Opening:

10¹/₂" x 14⁵/₈" x 3¹/₄"
(267 x 371 x 83 mm)



0135-1
TURBO-TUFF™ RECESS MOUNTED HIGH-SPEED ADA HAND DRYER (110-120V)

<15 sec.
DRYING TIME

68.9-74.3 dBA
NOISE LEVEL

Auto Shut Off: 60 seconds

Model Options:

- 0135-2** Voltage is 208-240 V

Unit Size:

12¹⁹/₃₂" x 15³/₄" x 4¹/₃₂"
(320 x 400 x 102 mm)

Wall Opening:

12⁵/₁₆" x 15³/₁₆" x 3⁷/₈"
(313 x 386 x 98 mm)



0198-MH
SAFE-DRI™ MENTAL HEALTH APPROVED RECESSED HIGH-SPEED HAND DRYER

<15 sec.
DRYING TIME

66 dBA
NOISE LEVEL

ANTI-LIGATURE

Voltage: 115-120 V (-1) and 208-240 V (-2)

Unit Size:

12⁵/₈" x 15³/₄" x 5¹/₁₆"
(320 x 400 x 140 mm)

Wall Opening:

11⁷/₈" x 14³/₄" x 5¹/₈"
(303 x 376 x 130 mm)





MIRRORS

A variety of reflective surfaces and wall mountings, as well as styles ranging from LED mirrors via frameless mirrors to mirrors with shelves and tilting features. Mirror silver guaranteed for 15 years.



OPTIONAL REFLECTIVE SURFACES

SUFFIX DESCRIPTION:

- B Tempered Glass** 1/4" (6 mm) polished tempered glass
- C Stainless Steel Mirrors** Type 304 Stainless Steel polished to a #8 mirror finish
- D Lexan Dura-Mir™** Fabricated of 1/4" (6 mm) polycarbonate sheet
- E Plexiglas®** 1/4" (6 mm) acrylic plastic, lightweight and shatter-resistant
- L Laminated Glass** 1/4" (6 mm) thick

Note for Designers: All of the above glazing options are particularly suited to applications where frequent breakage and/or security problems exist. These surfaces are best specified for use in prisons, schools, police stations, psychiatric wards, etc., where shards of broken glass might possibly be used as weapons. The reflective quality of these types of mirrors is not as true as plate glass.

STANDARD MIRROR SIZES													
Width x Height	0535	0537	0600	0600-T	0605	0620	0625	0640	0641	8026	20650	20650-B	20655
16" x 20" (41 x 51 cm)			■		■	■					■		
16" x 24" (41 x 61 cm)			■	■	■	■	■				■		
16" x 30" (41 x 76 cm)	■	■	■	■		■							
18" x 24" (46 x 61 cm)	■		■	■	■	■	■				■		
18" x 30" (46 x 76 cm)	■	■	■	■	■	■	■			■	■	■	■
18" x 36" (46 x 91 cm)	■	■	■	■	■	■	■				■	■	■
20" x 60" (51 x 152 cm)			■			■							
24" x 24" (61 x 61 cm)						■							
24" x 30" (61 x 76 cm)	■		■		■	■	■			■			
24" x 36" (61 x 91 cm)	■		■	■	■	■	■	■	■	■	■	■	■
24" x 42" (61 x 107 cm)			■			■							
24" x 48" (61 x 122 cm)			■			■							
24" x 60" (61 x 152 cm)			■			■							
24" x 72" (61 x 183 cm)			■										
30" x 36" (76 x 91 cm)			■			■		■	■				
30" x 48" (76 x 122 cm)						■							
36" x 36" (91 x 91 cm)			■			■							
36" x 48" (91 x 122 cm)						■							
48" x 30" (122 x 76 cm)			■		■	■							
48" x 36" (122 x 91 cm)			■		■	■		■	■				
60" x 24" (152 x 61 cm)			■		■	■							
60" x 36" (152 x 91 cm)			■		■	■		■	■				
72" x 36" (183 x 91 cm)			■		■	■							

Custom sizes available upon request. Standard glazing is glass. See optional reflective surfaces above.

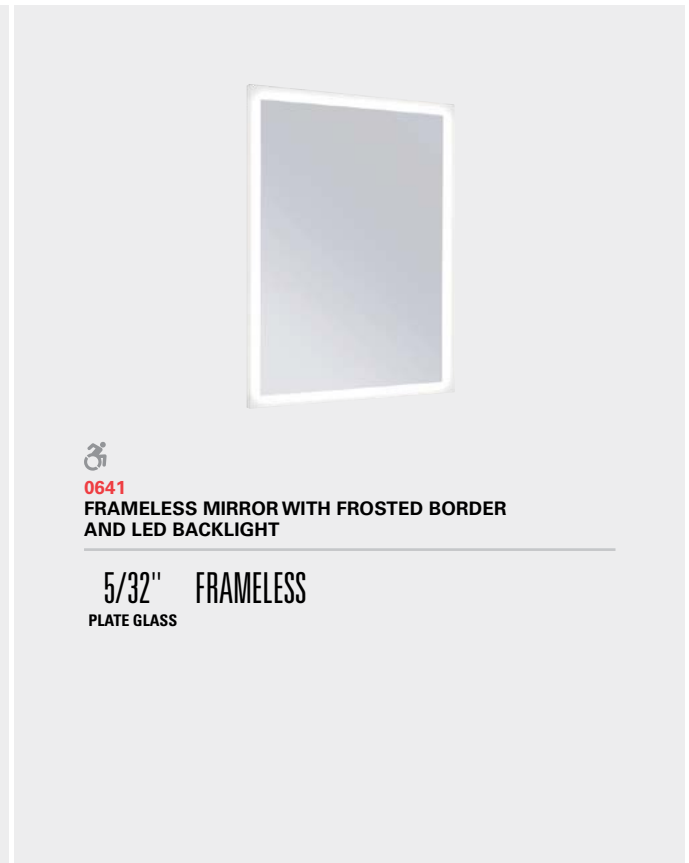



0600
ANGLE FRAME MIRROR

15 YEAR
WARRANTY

Model Option:
0600-41 Matte Black.



0620
CHANNEL FRAME MIRROR

15 YEAR
WARRANTY



20650
ROVAL™ MIRROR
20655
ROVAL™ MIRROR
WITH INTEGRAL SHELF

15 YEAR
WARRANTY

Model Options:
20650-B Mirror with tempered glass.



0605
ANGLE FRAME MIRROR
WITH SHELF
0625
CHANNEL FRAME MIRROR
WITH SHELF

15 YEAR
WARRANTY



0535
FIXED TILT MIRROR

15 YEAR
WARRANTY



0600-T
ADJUSTABLE TILT MIRROR

TILT **15 YEAR**
FRAME **WARRANTY**



8026

FRAMELESS STAINLESS STEEL MIRROR

15 YEAR
WARRANTY



8287

FRAMELESS MIRROR

FRAMELESS 15 YEAR
WARRANTY

VELARE™ COLLECTION

ALL-IN-ONE Cabinet houses a
– paper towel dispenser or high-speed hand dryer and
– a liquid soap- or foam-soap dispenser
Collection includes mirror fillers for design flexibility.

Backlit icons etched into the mirror facilitate an intuitive user experience.

ARTFULLY CONCEALED FRAMELESS





0952
RECESSED STAINLESS STEEL MEDICINE CABINET

ADJUSTABLE
 SHELVES

Overall Dimensions:
 18¼" x 24¼" x 4½"
 (464 x 616 x 114 mm)

Wall Opening:
 16" x 22¾" x 3½"
 (406 x 578 x 89 mm)

Model Option:
0952-B Larger than 0952.

Overall Dimensions:
 24" x 26" x 4⅞"
 (610 x 660 x 124 mm)

Wall Opening:
 21¾" x 24½" x 3½"
 (550 x 620 x 89 mm)



0953
SURFACE MOUNTED STAINLESS STEEL MEDICINE CABINET

ADJUSTABLE
 SHELVES

Overall Dimensions:
 18¼" x 24¼" x 4¾"
 (464 x 616 x 121 mm)



8340
RECESSED MEDICINE CABINET, POWDER COATED STEEL, MIRROR FRAME STAINLESS STEEL

1/4" **ADJUSTABLE**
 PLATE GLASS SHELVES

Overall Dimensions:
 18¼" x 24¼" x 4⅞"
 (465 x 615 x 120 mm)

Wall Opening:
 16" x 22¾" x 3½"
 (406 x 578 x 89 mm)

Model Options:
8338 Smaller and has two adjustable white baked enamel steel shelves.

Overall Dimensions:
 14⅞" x 20⅞" x 5"
 (359 x 513 x 125 mm)

8339 Larger than 8338.
 16¾" x 22¾" x 5"
 (411 x 564 x 127 mm)



DETAILS

UP TO
50
LB. CAPACITY

LARGE WEIGHT CAPACITY

Baby changing stations have been tested using ASTM F2285-04 and EN 12221-1 protocol for a static load and in addition have been tested to hold a weight up to 250 lbs [113kg].



ADA ACCESSIBILITY STANDARD COMPLIANT

Units are engineered to comply with the standards set forth by the Americans with Disabilities Act for accessibility and safety.



EASY OPEN AND CLOSE

Units are designed for easy one-handed operation and shaped to safely cradle a child's body.

BABY CHANGING STATIONS

PLASTIC



**PLASTIC/
STAINLESS STEEL**



STAINLESS STEEL





9014
SURFACE MOUNTED HORIZONTAL PLASTIC
BABY CHANGING STATION

≤250 lbs.

Overall Dimensions:

Closed:
 35⁵/₃₂" x 24¹/₄" x 3⁷/₁₆"
 (893 x 616 x 98 mm)

Open:
 35⁵/₃₂" x 24¹/₄" x 22¹/₃₂"
 (893 x 616 x 560 mm)



9014-41
SURFACE MOUNTED HORIZONTAL MATTE BLACK
BABY CHANGING STATION

≤250 lbs.

Overall Dimensions:

Closed:
 35⁵/₃₂" x 24¹/₄" x 3⁷/₁₆"
 (893 x 616 x 98 mm)

Open:
 35⁵/₃₂" x 24¹/₄" x 22¹/₃₂"
 (893 x 616 x 560 mm)



9012
SURFACE MOUNTED PLASTIC BABY CHANGING STATION

≤250 lbs.

Overall Dimensions:

Closed:
 36" x 22" x 4"
 (914 x 559 x 102 mm)

Open:
 36" x 22" x 20⁷/₁₆"
 (914 x 559 x 519 mm)



9015
SURFACE MOUNTED VERTICAL PLASTIC
BABY CHANGING STATION

≤250 lbs.

Overall Dimensions:

Closed:
 24¹/₄" x 35⁵/₃₂" x 3⁷/₁₆"
 (616 x 893 x 98 mm)

Open:
 24¹/₄" x 35⁵/₃₂" x 32¹⁵/₁₆"
 (616 x 893 x 837 mm)

BABY CHANGING STATIONS



9022
**SURFACE MOUNTED HORIZONTAL PLASTIC/
 STAINLESS STEEL BABY CHANGING STATION**

≤250 lbs.

Overall Dimensions:

Closed:

35⁵/₃₂" x 24¹/₄" x 3⁷/₈"
 (893 x 616 x 98 mm)

Open:

35⁵/₃₂" x 24¹/₄" x 22¹/₃₂"
 (893 x 616 x 560 mm)



9024-41
**SURFACE MOUNTED HORIZONTAL MATTE BLACK
 STAINLESS STEEL PANEL BABY CHANGING STATION**

≤250 lbs.

Overall Dimensions:

Closed:

35⁵/₃₂" x 24¹/₄" x 3⁷/₈"
 (893 x 616 x 98 mm)

Open:

35⁵/₃₂" x 24¹/₄" x 22¹/₃₂"
 (893 x 616 x 560 mm)



9026-41
**SURFACE MOUNTED HORIZONTAL
 STAINLESS STEEL (MATTE BLACK/MATTE BLACK)
 BABY CHANGING STATION**

≤250 lbs.

Overall Dimensions:

Closed:

35⁵/₃₂" x 24¹/₄" x 3⁷/₈"
 (893 x 616 x 98 mm)

Open:

35⁵/₃₂" x 24¹/₄" x 22¹/₃₂"
 (893 x 616 x 560 mm)



9020
SURFACE MOUNTED TODDLER SAFETY SEAT

≤250 lbs.

Overall Dimensions:

Closed:

12¹/₂" x 21³/₄" x 5¹/₂"
 (318 x 552 x 140 mm)

Open:

12¹/₂" x 21³/₄" x 11¹/₈"
 (318 x 552 x 283 mm)



9018-41
RECESSED HORIZONTAL MATTE BLACK
STAINLESS STEEL BABY CHANGING STATION

≤250 lbs.

Overall Dimensions:

Closed:
 35⁵/₃₂" x 24¹/₄" x 3⁷/₁₆"
 (893 x 616 x 98 mm)

Open:
 35⁵/₃₂" x 24¹/₄" x 22¹/₃₂"
 (893 x 616 x 560 mm)



9018-9-41
SURFACE MOUNTED HORIZONTAL MATTE BLACK
STAINLESS STEEL BABY CHANGING STATION

≤250 lbs.

Overall Dimensions:

Closed:
 39⁵/₃₂" x 28¹/₄" x 3⁵/₁₆"
 (995 x 718 x 10 mm)

Open:
 39⁵/₃₂" x 28¹/₄" x 18¹/₁₆"
 (995 x 718 x 460 mm)



9017
RECESSED VERTICAL STAINLESS STEEL
BABY CHANGING STATION

≤250 lbs.

Overall Dimensions:

Closed:
 28¹/₄" x 39⁵/₃₂" x 3⁵/₁₆"
 (718 x 994 x 10 mm)

Open:
 28¹/₄" x 39⁵/₃₂" x 29³/₁₆"
 (718 x 994 x 746 mm)

Wall Opening:
 24¹/₂" x 35¹/₂" x 4" min
 (622 x 902 x 102 mm)



9017-9
SURFACE MOUNTED VERTICAL STAINLESS STEEL
BABY CHANGING STATION

≤250 lbs.

Overall Dimensions:

Closed:
 28¹/₄" x 39⁵/₃₂" x 3⁵/₁₆"
 (718 x 995 x 100 mm)

Open:
 28¹/₄" x 39⁵/₃₂" x 32³/₈"
 (718 x 995 x 822 mm)

Wall Opening:
 24¹/₂" x 35¹/₂" x 4" min
 (622 x 902 x 102 mm)

BABY CHANGING STATIONS



9018-9
SURFACE MOUNTED HORIZONTAL STAINLESS STEEL
BABY CHANGING STATION

≤250 lbs.

Overall Dimensions:

Closed:	Open:
39 ⁷ / ₃₂ " x 28 ¹ / ₄ " x 3 ³ / ₁₆ "	39 ⁷ / ₃₂ " x 28 ¹ / ₄ " x 18 ¹ / ₈ "
(995 x 718 x 84 mm)	(995 x 718 x 460 mm)



9018
RECESSED HORIZONTAL STAINLESS STEEL
BABY CHANGING STATION

≤250 lbs.

Overall Dimensions:

Closed:	Open:
39 ⁷ / ₃₂ " x 28 ¹ / ₄ " x ³ / ₈ "	39 ⁷ / ₃₂ " x 28 ¹ / ₄ " x 18 ¹ / ₈ "
(995 x 718 x 10 mm)	(995 x 718 x 460 mm)

Wall Opening:
 35¹/₂" x 24¹/₂" x 4" min
 (902 x 622 x 102 mm)



9013
RECESSED STAINLESS STEEL BABY CHANGING STATION

≤250 lbs.

Overall Dimensions:

Closed:	Open:
37" x 25 ¹ / ₂ " x ³ / ₈ "	37" x 25 ¹ / ₂ " x 17 ³ / ₄ "
(940 x 648 x 10 mm)	(940 x 648 x 451 mm)



9013-9
SURFACED MOUNTED STAINLESS STEEL
BABY CHANGING STATION

≤250 lbs.

Overall Dimensions:

Closed:	Open:
37" x 25 ¹ / ₂ " x 4 ³ / ₈ "	37" x 25 ¹ / ₂ " x 21 ³ / ₄ "
(940 x 648 x 111 mm)	(940 x 648 x 552 mm)



SHELVES

Various configurations, sizes, and styles, including platform, recessed, and folding utility shelving.

SHELVES
ALL STAINLESS STEEL IS TYPE 304 WITH SATIN FINISH,
UNLESS OTHERWISE NOTED.



**RECESSED
SHELF**



**SURFACED
MOUNTED
SHELF**



0690
SHELF WITH RAISED EDGES

SURFACE **RAISED**
MOUNTED **EDGES**

See chart for standard sizes.

	Model Numbers					
	0690	0692		0694	20692	
Standard Sizes:	6" depth (152 mm)	5" depth (127 mm)	6" depth (152 mm)	8" depth (203 mm)	5" depth (127 mm)	6" depth (152 mm)
Length						
12" (305 mm)		■	■	■		■
16" (406 mm)		■	■	■		
18" (457 mm)	■	■	■	■	■	■
24" (610 mm)	■	■	■	■	■	■
30" (762 mm)		■	■	■		■
36" (914 mm)		■	■	■		■
48" (1219 mm)		■	■	■	■	■
60" (1524 mm)		■	■	■	■	■
72" (1829 mm)						■



0692 SERIES
SURFACE MOUNTED SHELF

Model Options:
0692-5xx 5" Depth.
0692-6xx 6" Depth.
0692-8xx 8" Depth.

See chart for standard sizes.



0698
FOLDING UTILITY SHELF FOR TOILET COMPARTMENTS

SURFACE **FOLD DOWN**
MOUNTED TYPE

Overall Dimensions:
14⁵/₈" x 5¹/₈"
(371 x 148 mm)



0412
RECESSED SHELF

Overall Dimensions:
18" x 8" x 4¹/₄" min
(457 x 203 x 108 mm)

Wall Opening:
16¹/₂" x 6¹/₂" x 4" min
(419 x 165 x 102 mm)



0694 SERIES
SURFACE MOUNTED SHELF
WITH BACKSPLASH



20692 SERIES
ROVAL™ SURFACE MOUNTED
SHELF, 6" DEPTH

For various lengths add suffix-6XX.

See chart for standard sizes.



FEMININE HYGIENE VENDORS

Recessed, semi-recessed, or surface-mounted dispensers in various capacities. Coin boxes for 25ct and 50ct are separately keyed from door locks.

FEMININE HYGIENE VENDORS AND DISPOSALS



**SANITARY
NAPKIN/TAMPON
VENDOR**



0464

**SEMI-RECESSED STAINLESS STEEL
SANITARY NAPKIN & TAMPON VENDOR**

27

**TAMPON
CAPACITY**

Model Option:
0864 Surface mounted.

Unit Size:
13³/₄" x 28¹/₈" x 6¹/₂"
(349 x 714 x 165 mm)

Wall Opening:
12¹/₂" x 26¹/₂" x 1" to 6"
(318 x 673 x 25 to 152 mm)



6468

**SIMPLICITY™ RECESSED STAINLESS STEEL
SANITARY NAPKIN & TAMPON VENDOR**

27

**TAMPON
CAPACITY**

Model Option:
64684 Designed for 4" (102 mm) wall opening;
dispenses 15 napkins and 23 tampons.

Unit Size:
17¹/₄" x 27¹/₄" x 6¹/₂"
(438 x 692 x 165 mm)

Wall Opening:
16" x 26" x 6¹/₄"
(406 x 660 x 159 mm)



0468
RECESSED STAINLESS STEEL
SANITARY NAPKIN & TAMPON VENDOR

27

TAMPON
CAPACITY

Model Options:

0468-2 Semi-recessed with a stainless steel collar.

04684 Designed for 4" (102 mm) wall. Dispenses 15 napkins, 23 tampons.

Unit Size:

17¼" x 27¼" x 6½"
 (438 x 692 x 165 mm)

Wall Opening:

16" x 26" x 6"
 (406 x 660 x 152 mm)



204684
ROVAL™ RECESSED STAINLESS STEEL
SANITARY NAPKIN & TAMPON VENDOR

22

TAMPON
CAPACITY

Model Option:

204684-9 Surface mounted with a stainless steel collar.

Unit Size:

17⅞" x 27¾" x 5⅝"
 (440 x 705 x 143 mm)

Wall Opening:

15⅞" x 26⅞" x 4"
 (397 x 664 x 102 mm)



DETAILS



TUMBLER LOCKS

Our tumbler locks provide convenience and security with an elegant look.



SAFE, EASY DISPENSING

Dispensing and storage options vary, from single-roll to multiple-rolls or jumbo-roll dispensers.



VIEWING SLOT

Slot in front cover of jumbo-roll dispensers provides easy visual indication of remaining tissue supply.

TOILET TISSUE DISPENSERS

A broad range of designs for a broad range of applications.



**SHELF AND
DOUBLE
TOILET TISSUE
HOLDER**



**DUAL ROLL
TOILET TISSUE
DISPENSERS**



**RECESSED
ADA-COMPLIANT
TOILET TISSUE
AND SEAT COVER
DISPENSER WITH
WASTE DISPOSAL**

See our Toilet Tissue
Combination Units,
pages 125-127.



0030
**SURFACE MOUNTED DUAL ROLL
TOILET TISSUE DISPENSER**

2

TOILET PAPER
CAPACITY (ROLLS)

Unit Size:
6" x 12" x 6½"
(152 x 305 x 165 mm)



0030-41
**MATTE BLACK TOILET TISSUE
DISPENSER, TWIN HIDE-A-ROLL –
SURFACE MOUNTED**

2

TOILET PAPER
CAPACITY (ROLLS)

Unit Size:
6" x 12" x 6½"
(152 x 305 x 165 mm)



20030
**ROVAL™ SURFACE MOUNTED
TWIN HIDE-A-ROLL TOILET
TISSUE DISPENSER**

2

TOILET PAPER
CAPACITY (ROLLS)

Model Option:
20031 With flange for
semi-recessed mounting.

Overall Dimensions:
6⅞" x 12⅞" x 6½"
(154 x 308 x 165 mm)



0031
RECESSED DUAL ROLL TOILET TISSUE DISPENSER

2

TOILET PAPER
CAPACITY (ROLLS)

Unit Size: 8" x 14" x 6½"
(203 x 356 x 165 mm)
Wall Opening: 6¼" x 12¼" x 3⅞"
(159 x 311 x 86 mm)



0032
**PARTITION MOUNTED DUAL ACCESS DUAL ROLL
TOILET TISSUE DISPENSER**

4

TOILET PAPER
CAPACITY (ROLLS)

**PARTITION
MOUNTED**

Unit Size: 14" x 14⅞" x 10"
(356 x 359 x 255 mm)
Partition Opening: 12⅞" x 12¼" x ½-2½"
(308 x 311 x 13-64 mm)



0039

SURFACE MOUNTED LOW PROFILE TWIN 9" JUMBO ROLL TOILET TISSUE DISPENSER

TWIN JUMBO

TOILET PAPER
CAPACITY (ROLLS)

Overall Dimensions:
20½" x 11¾" x 4⅛"
(521 x 284 x 119 mm)



0040

SURFACE MOUNTED TWIN 9" JUMBO ROLL TOILET TISSUE DISPENSER

TWIN JUMBO

TOILET PAPER
CAPACITY (ROLLS)

Overall Dimensions:
20⅞" x 11¾" x 6⅞"
(529 x 289 x 157 mm)



0042

SURFACE MOUNTED 9" JUMBO ROLL TOILET TISSUE DISPENSER

JUMBO

TOILET PAPER
CAPACITY (ROLLS)

Model Option:
0046 Jumbo 12" roll, surface mounted.

Overall Dimensions:
10⅝" x 10⅝" x 4½"
(270 x 270 x 114 mm)



0042-41

MATTE BLACK SURFACE MOUNTED 9" JUMBO ROLL TOILET TISSUE DISPENSER

JUMBO

TOILET PAPER
CAPACITY (ROLLS)

Overall Dimensions:
10⅝" x 10⅝" x 4½"
(270 x 270 x 114 mm)



7402-BSM
TOILET TISSUE HOLDER (SINGLE) – SURFACE MOUNTED, BRIGHT

1

TOILET PAPER CAPACITY (ROLLS)

Model Option:
7402-B Recessed, bright.

Overall Dimensions:
6⁵/₁₆" x 6⁵/₁₆"
(160 x 160 mm)



7402-HB
TOILET TISSUE HOLDER WITH HOOD (SINGLE) – RECESSED, BRIGHT

1

TOILET PAPER CAPACITY (ROLLS)

Model Option:
7402-HS Recessed, satin.

Overall Dimensions:
6⁵/₁₆" x 6⁵/₁₆"
(160 x 160 mm)



7402-SSM
TOILET TISSUE HOLDER (SINGLE) – SURFACE MOUNTED, SATIN

1

TOILET PAPER CAPACITY (ROLLS)

Model Option:
7402-S Recessed, satin.

Overall Dimensions:
6⁵/₁₆" x 6⁵/₁₆"
(160 x 160 mm)



7402-HBSM
TOILET TISSUE HOLDER WITH HOOD (SINGLE) – SURFACE MOUNTED, BRIGHT

1

TOILET PAPER CAPACITY (ROLLS)

Model Option:
7402-HSSM Surface mounted, satin.

Overall Dimensions:
10⁵/₁₆" x 10⁵/₁₆" x 4¹/₂"
(270 x 270 x 114 mm)

TOILET TISSUE DISPENSERS

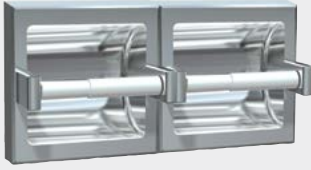

74022-BSM
TOILET TISSUE HOLDER (DOUBLE)
– SURFACE MOUNTED, BRIGHT

2

TOILET PAPER
CAPACITY (ROLLS)

Model Option:
74022-B Recessed, bright.

Overall Dimensions:
12⁵/₈" x 6⁵/₁₆" x 2"
(320 x 160 x 51 mm)



74022-HBSM
TOILET TISSUE HOLDER WITH
HOOD (DOUBLE) – SURFACE
MOUNTED, BRIGHT

2

TOILET PAPER
CAPACITY (ROLLS)

Overall Dimensions:
12⁵/₈" x 6⁵/₁₆" x 2"
(320 x 160 x 51 mm)



74022-HSSM
TOILET TISSUE HOLDER WITH
HOOD (DOUBLE) – SURFACE
MOUNTED, SATIN

2

TOILET PAPER
CAPACITY (ROLLS)

Model Option:
74022-HS Recessed, satin.

Overall Dimensions:
12⁵/₈" x 6⁵/₁₆" x 2"
(320 x 160 x 51 mm)



74022-SSM
TOILET TISSUE HOLDER (DOUBLE)
– SURFACE MOUNTED, SATIN

2

TOILET PAPER
CAPACITY (ROLLS)

Model Option:
74022-S Recessed, satin.

Overall Dimensions:
12⁵/₈" x 6⁵/₁₆" x 2"
(320 x 160 x 51 mm)



7403-B
SPARE ROLL TOILET TISSUE
HOLDER – RECESSED,
SATIN FINISH

2

TOILET PAPER
CAPACITY (ROLLS)

Model Option:
7403-S Satin.

Overall Dimensions:
6⁵/₁₆" x 6¹/₄" x 6¹³/₁₆"
(160 x 160 x 173 mm)



7305-S
SURFACE MOUNTED TOILET
TISSUE HOLDER, SATIN FINISH

1

TOILET PAPER
CAPACITY (ROLLS)

Model Options:
7305-41 Surface mounted,
matte black.
7305-B Surface mounted, bright.

Overall Dimensions:
6¹/₁₆" x 12¹/₈" x 6¹/₂"
(154 x 308 x 165 mm)



0705-Z
**SURFACE MOUNTED ZAMAK
 CHROME PLATED TOILET
 TISSUE HOLDER**

1

**TOILET PAPER
 CAPACITY (ROLLS)**

Overall Dimensions:
 5⁷/₈" x 1⁷/₁₆" x 2³/₄"
 (149 x 37 x 70 mm)



0697-GAL
**SURFACE MOUNTED STAINLESS
 STEEL SHELF AND DOUBLE TOILET
 TISSUE HOLDER**

2

**TOILET PAPER
 CAPACITY (ROLLS)**

Overall Dimensions:
 18" x 4¹³/₁₆" x 5"
 (457 x 106 x 127 mm)



7305-2B
**SURFACE MOUNTED DOUBLE
 TOILET TISSUE HOLDER**

2

**TOILET PAPER
 CAPACITY (ROLLS)**

Model Options:
7305-2-41 Matte black.
7305-2S Satin.

Overall Dimensions:
 3¹/₂" x 2" x 3³/₈"
 (343 x 51 x 98 mm)



7314
**SINGLE TOILET PAPER ROLL
 HOLDER**

1

**TOILET PAPER
 CAPACITY (ROLLS)**

Overall Dimensions:
 5³/₁₆" x 3³/₈" x 2³/₁₆"
 (131 x 86 x 56 mm)



7314-H
**TOILET TISSUE ROLL HOLDER
 (SINGLE), HOODED**

1

**TOILET PAPER
 CAPACITY (ROLLS)**

Overall Dimensions:
 5⁴/₁₆" x 4³/₄" x 3³/₈"
 (144 x 121 x 98 mm)



7316
**TOILET TISSUE SPARE
 HOLDER, VERTICAL**

1

**TOILET PAPER
 CAPACITY (ROLLS)**

Overall Dimensions:
 3¹/₂" x 6⁷/₁₆" x 4"
 (90 x 163.5 x 102 mm)

TOILET TISSUE DISPENSERS



0264-1
**SURFACE MOUNTED DOUBLE
 CAST ALUMINUM TOILET
 TISSUE HOLDER – SPINDLES**
 ABS-THERMOPLASTIC

2

**TOILET PAPER
 CAPACITY (ROLLS)**

Model Options:

0264-12 Unrestricted delivery,
 theft-resistant spindle.
0264-1A Unrestricted delivery.
0264-1A2 Unrestricted delivery,
 theft-resistant spindle.

Overall Dimensions:
 13" x 1¾" x 4¾"
 (330 x 45 x 120 mm)



0263-1
**SURFACE MOUNTED SINGLE
 CAST ALUMINUM ROLL TOILET
 TISSUE DISPENSER – SPINDLES**
 ABS-THERMOPLASTIC

1

**TOILET PAPER
 CAPACITY (ROLLS)**

CONTROLLED
 DELIVERY

Model Option:

0263-1A Unrestricted delivery.

Overall Dimensions:
 6½" x 1¾" x 4"
 (165 x 45 x 102 mm)



8010
**SURFACE MOUNTED TOILET TISSUE
 HOLDER (SINGLE) HIGH POLISHED
 CHROME PLATED STEEL**

1

**TOILET PAPER
 CAPACITY (ROLLS)**

Overall Dimensions:
 5⅝" x 2⅝" x 4¼"
 (143 x 60 x 108 mm)



048234
**RECESSED MULTI-ROLL
 TOILET TISSUE DISPENSER**

4

**TOILET PAPER
 CAPACITY (ROLLS)**

Unit Size:

17⅞" x 20" x 4¼"
 (441 x 508 x 108 mm)

Wall Opening:

15¾" x 18⅝" x 4"
 (400 x 467 x 102 mm)



0710
**SURFACE MOUNTED TOILET TISSUE
 HOLDER (SINGLE) HIGH POLISHED
 CHROME PLATED STEEL**

1

**TOILET PAPER
 CAPACITY (ROLLS)**

Overall Dimensions:
 6" x 2¾" x 4¼"
 (152 x 70 x 108 mm)



0715
**SURFACE MOUNTED DOUBLE
 TOILET TISSUE HOLDER HIGH
 POLISHED CHROME PLATED STEEL**

2

**TOILET PAPER
 CAPACITY (ROLLS)**

Overall Dimensions:
 12⅞" x 2¾" x 4¼"
 (314 x 70 x 108 mm)



0266

STAINLESS STEEL VANDAL-RESISTANT HOOD

1

TOILET PAPER
CAPACITY (ROLLS)

SURFACE
MOUNTED

Model Options:

0267 Vandal-resistant hood for model 0264-1 (hood only)
– surface mounted.

Unit Size:

7¼" x 7¾" x 6½"
(184 x 197 x 175 mm)



R-002

**THEFT-RESISTANT SPINDLE
FOR 0263 AND 0264 SERIES**

1

TOILET PAPER
CAPACITY (ROLLS)

Overall Dimensions:

4"
(102 mm)



7303-B

EXTRA ROLL TOILET TISSUE HOLDER

1

TOILET PAPER
CAPACITY (ROLLS)

SURFACE
MOUNTED

Model Option:

7303-S Satin Finish.

Overall Dimensions:

1" x 5" x 4¾"
(25 x 127 x 111 mm)



8020

**SURFACE MOUNTED SAV-HAFTOILET TISSUE HOLDER
1/8" (3MM) THICK CLEAR ANODIZED ALUMINUM
WITH A SATIN FINISH**

1

TOILET PAPER
CAPACITY (ROLLS)

Overall Dimensions:

5/8" x 2" x 3½"
(130 x 51 x 79 mm)

TOILET TISSUE DISPENSERS



R-005
SPINDLE FOR CORELESS ROLLS

1

TOILET PAPER
CAPACITY (ROLLS)

Overall Dimensions:

5 $\frac{3}{8}$ "
(137 mm)



R-009
THEFT-RESISTANT SPINDLE

1

TOILET PAPER
CAPACITY (ROLLS)

Overall Dimensions:

4" x 1 $\frac{3}{16}$ "
(102 x 30 mm)



R-003
CHROME-PLATED SPINDLE

1

TOILET PAPER
CAPACITY (ROLLS)

Overall Dimensions:

4"
(102 mm)



R-004
ROLLER FOR 0030 TOILET TISSUE DISPENSER SERIES

1

TOILET PAPER
CAPACITY (ROLLS)

Overall Dimensions:

4"
(102 mm)



TOILET SEAT COVER DISPENSERS

Have a seat – matching designs for maximum comfort during downtime.



**RECESSED
TOILET SEAT
COVER
DISPENSERS**



**SURFACE
MOUNTED
TOILET SEAT
COVER
DISPENSERS**



0477

**RECESSED TOILET SEAT
COVER DISPENSER**

500 SINGLE
OR HALF-FOLD
PAPER SEAT
COVERS

Overall Dimensions:

17¼" x 12¾" x 2⅝"
(438 x 324 x 66 mm)

Wall Opening:

15¾" x 11¼" x 2⅝"
(400 x 285 x 60 mm)



0477-SM

**SURFACE MOUNTED TOILET SEAT
COVER DISPENSER**

250 SINGLE
OR HALF-FOLD
PAPER SEAT
COVERS

Unit Size:

17¼" x 12¾" x 2⅝"
(438 x 324 x 60 mm)



0477-SM-41

**MATTE BLACK SURFACE
MOUNTED TOILET SEAT
COVER DISPENSER**

250 SINGLE
OR HALF-FOLD
PAPER SEAT
COVERS

Unit Size:

15¾" x 11" x 1⅞"
(400 x 279 x 48 mm)

TOILET SEAT COVER DISPENSERS



20477-SM
**ROVAL™ SURFACE MOUNTED
SEAT COVER DISPENSER**

250 SINGLE
OR HALF-FOLD
PAPER SEAT
COVERS

Overall Dimensions:
15¾" x 11" x 2⅝"
(400 x 280 x 60 mm)



6477
**SIMPLICITY™ RECESSED TOILET
SEAT COVER DISPENSER**

500 SINGLE
OR HALF-FOLD
PAPER SEAT
COVERS

Unit Size:
17¼" x 12¾" x 2⅞"
(438 x 324 x 73 mm)
Wall Opening:
15¾" x 11½" x 2⅝"
(400 x 292 x 60 mm)



6477-9
**SIMPLICITY™ SURFACE MOUNTED
TOILET SEAT COVER DISPENSER**

500 SINGLE
OR HALF-FOLD
PAPER SEAT
COVERS

Overall Dimensions:
17¼" x 12¾" x 2⅞"
(438 x 324 x 73 mm)



HYGIENE DISPOSALS

Sensitive attention for the most hygienic waste management. Sensitive designs integrated into the aesthetic lines and functional applications – from capacity management in high traffic areas to withdrawn humbleness in premium restrooms.



**SANITARY
WASTE
RECEPTACLE**



**SANITARY
WASTE
RECEPTACLE**



0472

**PARTITION MOUNTED DUAL ACCESS
NAPKIN DISPOSAL**

1.5 gal.
WASTE CAPACITY
(5.7 L)

**PARTITION
MOUNTED**

Model Option:
0472-1 Waste receptacle unit with lock.

Unit Size:
13" x 17¼" x 4"
(330 x 438 x 102 mm)

Partition Opening:
11⅜" x 15⅝"
(290 x 400 mm)



0473

RECESSED SANITARY NAPKIN DISPOSAL

1.5 gal.
WASTE CAPACITY
(5.7 L)

Model Option:
0473-1 Waste receptacle unit with lock.

Unit Size:
13" x 17¼" x 4¼"
(330 x 438 x 108 mm)

Wall Opening:
11¼" x 15¾" x 4"
(285 x 400 x 102 mm)



0473-A

**SURFACE MOUNTED END STALL
SANITARY NAPKIN DISPOSAL**

1.5 gal.
WASTE CAPACITY
(5.7 L)

Overall Dimensions:
11" x 15¼" x 4"
(279 x 387 x 102 mm)



0473-1A

**SURFACE MOUNTED END STALL SANITARY NAPKIN
DISPOSAL WITH LOCK**

1.5 gal.
WASTE CAPACITY
(5.7 L)

Overall Dimensions:
11" x 15¼" x 4"
(279 x 387 x 102 mm)



6471
SIMPLICITY™ RECESSED SANITARY NAPKIN DISPOSAL

1.4 gal.
WASTE CAPACITY
(5.4 L)

Unit Size:
10⁵/₈" x 19⁵/₈" x 4¹/₂"
(270 x 498 x 114 mm)

Wall Opening:
9¹/₈" x 18¹/₈" x 4"
(232 x 460 x 102 mm)



0852
SURFACE MOUNTED SANITARY NAPKIN DISPOSAL

1.2 gal.
WASTE CAPACITY
(4.5 L)

Overall Dimensions:
7⁷/₈" x 9¹¹/₁₆" x 4"
(200 x 246 x 102 mm)



20470
ROVAL™ RECESSED SANITARY NAPKIN DISPOSAL

1.0 gal.
WASTE CAPACITY
(3.7 L)

Overall Dimensions:
12¹³/₁₆" x 11" x 5⁷/₁₆"
(325 x 280 x 138 mm)



20852
ROVAL™ SURFACE MOUNTED SANITARY WASTE RECEPTACLE

1.0 gal.
WASTE CAPACITY
(3.7 L)

Overall Dimensions:
7¹/₄" x 10" x 3¹/₂"
(185 x 253 x 89 mm)



GRAB BARS

All grab bars are made in compliance with ADA guidelines and other international regulations for strength requirements. Various configurations are available in satin finish 18 gauge type 304 stainless steel (peened or smooth), and powder coated matte black or white finishes. Grab bars are heliarc welded.

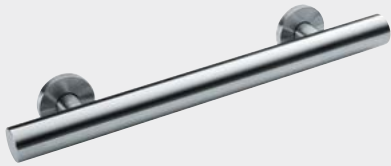

OMARA GRAB BAR
7801 Series – 1½" (38 mm) O.D.

CONCEALED
 MOUNTING STYLE

7801-18 18"
7801-24 24"
7801-36 36"
7801-42 42"

SUFFIX OPTION:
 P: Peened.



SNAP FLANGE
3700 Series – 1¼" (32 mm) O.D.
3800 Series – 1½" (38 mm) O.D.

18 **CONCEALED**
 GAUGE MOUNTING STYLE

Model Options:
3700-W White.
3800-W White.
3801-41 Matte Black.
3801-18-41 18" Matte Black.
3801-24-41 24" Matte Black.
3801-36-41 36" Matte Black.
3801-42-41 42" Matte Black.

SUFFIX OPTION:
 P: Peened.



EXPOSED MOUNTING
3400 Series – 1¼" (32 mm) O.D.
3500 Series – 1½" (38 mm) O.D.

EXPOSED
 MOUNTING STYLE

SUFFIX OPTION:
 P: Peened.

GRAB BAR CONFIGURATIONS

The following standard shapes are typical configurations. Grab bars can be custom designed and manufactured to meet any specific architectural requirement.

Designers Note:

For a non-slip surface, specify suffix "P" (peened). When specifying grab bars, insert the configuration type numbers listed below into the double zeros at the end of the grab bar series number.

Example 1: A 1½" (38 mm) concealed 18" x 33" (460 x 840 mm) horizontal grab bar has a model number—3874. When a special size is needed, add suffix "M" plus the size, to the closest standard bars.

Example 2: A 1½" (38 mm) concealed 23" x 37" (585 x 940 mm) horizontal grab bar has a model number 3874-M2337.

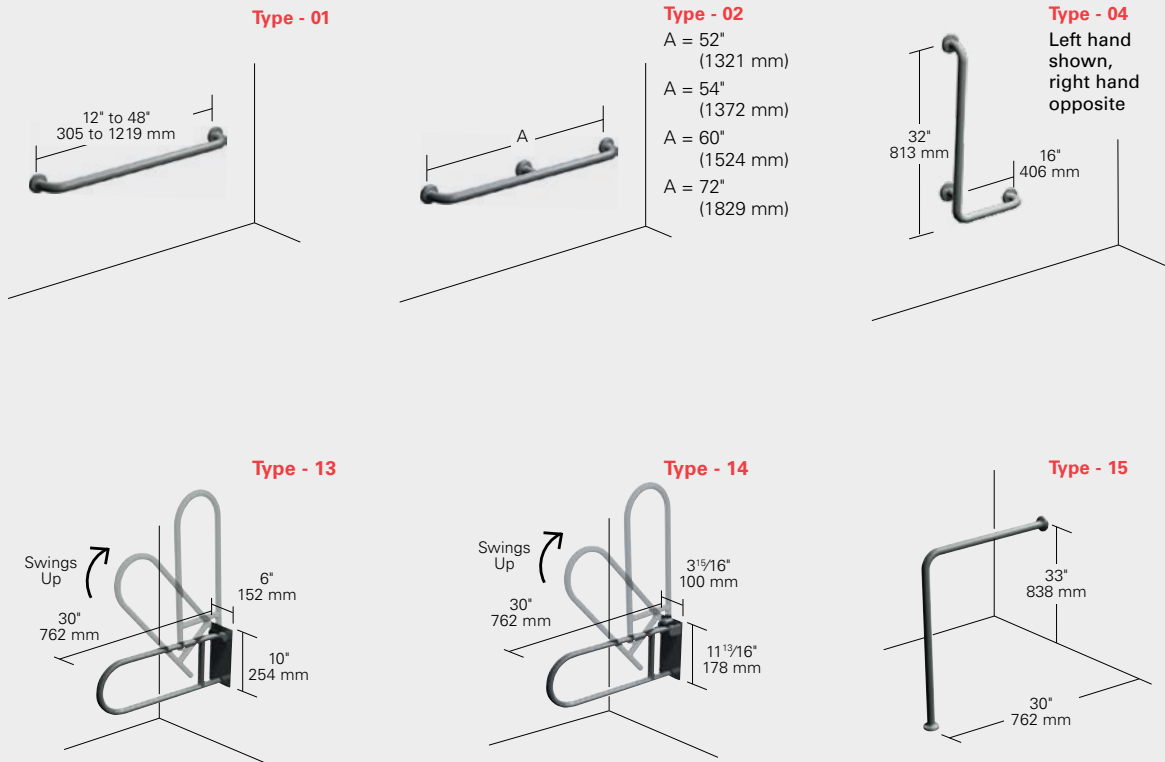

Type - 20



Type - 24

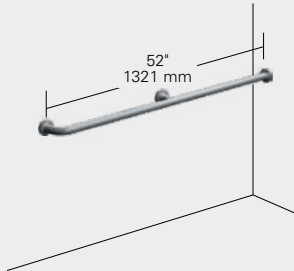

Type - 33
Right hand shown,
left hand opposite

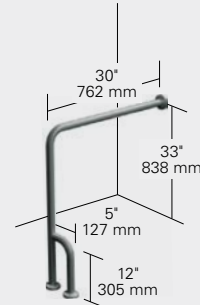

Type - 34

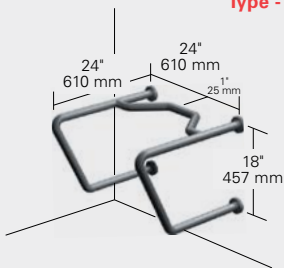

Type - 51

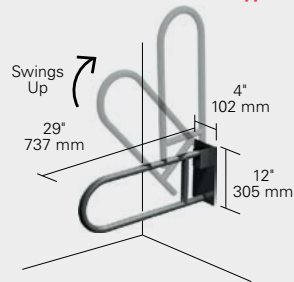

Type - 75



Type - 50

A = 24"
(610 mm)
B = 36"
(914 mm)

Type - 60

A = 18"
(457 mm)
B = 30"
(762 mm)

Type - 56

A = 36"
(914 mm)
B = 54"
(1372 mm)

Type - 74

A = 18 1/8"
(460 mm)
B = 33 1/8"
(841 mm)

Type - 57

A = 42"
(1067 mm)
B = 54"
(1372 mm)

Type - 54

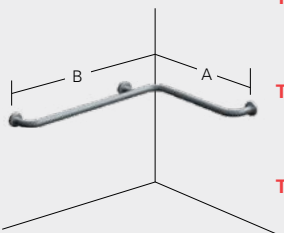
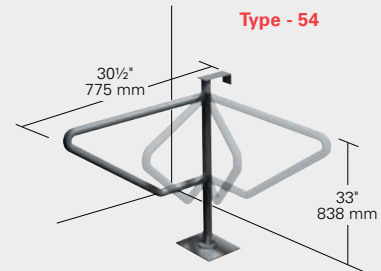



HOOKS

The distinction is in the details for one of the smallest but not least important items inside the toilet. Matching designs for any of the aesthetic lines as well as functional applications.



**ROBE
HOOK**



**TOWEL
PIN**



**HAT AND
COAT HOOK**



7308
SINGLE ROBE HOOK

SINGLE
HOOK



7312
DOUBLE ROBE HOOK

DOUBLE
HOOK





7340-S
SINGLE ROBE HOOK –
SATIN FINISH

SINGLE
HOOK

Unit Size:
2" x 2" x 2"
(51 x 51 x 51 mm)





7340-B
SINGLE ROBE HOOK –
BRIGHT FINISH

SINGLE
HOOK

Unit Size:
2" x 2" x 2"
(51 x 51 x 51 mm)



7340-41
SINGLE ROBE HOOK –
MATTE BLACK

SINGLE
HOOK

Unit Size:
2" x 2" x 2"
(51 x 51 x 51 mm)



7345-S
DOUBLE ROBE HOOK – SATIN FINISH

DOUBLE
HOOK

Overall Dimensions:
4" x 2" x 2"
(102 x 51 x 51 mm)



7345-B
DOUBLE ROBE HOOK – BRIGHT FINISH

DOUBLE
HOOK

Overall Dimensions:
4" x 2" x 2"
(102 x 51 x 51 mm)



7301-B
TOWEL PIN

Model Option:
7301-S Towel pin with satin finish.

Overall Dimensions:
2" x 2" x 3½"
(51 x 51 x 89 mm)



7382-S
HAT AND COAT HOOK – SATIN FINISH

Overall Dimensions:
2" x 7" x 3"
(51 x 178 x 76 mm)



7382-B
HAT AND COAT HOOK – BRIGHT FINISH

Overall Dimensions:
2" x 7" x 3"
(51 x 178 x 76 mm)



8425
CLOTHES HOOK



0714
COAT AND BUMPER HOOK, CHROME PLATED BRASS

WITH BUMPER

Overall Dimensions:
2³/₁₆" (56 mm) diameter flange.
Projects 1⁷/₈" (48 mm).



0751
**HEAVY-DUTY ROBE HOOK – CONCEALED,
CHROME PLATED BRASS**

≤181 lbs.



0751-A
**HEAVY-DUTY ROBE HOOK – EXPOSED,
CHROME PLATED BRASS**

≤181 lbs.

Overall Dimensions:
Exposed mounting, satin chrome plated brass, projects
3¹/₄" (83 mm)



0740-Z
SINGLE ROBE HOOK, CHROME PLATED ZAMAK

SINGLE
HOOK

Overall Dimensions:
2 1/8" x 1 7/16" x 2 1/8"
(54 x 37 x 54 mm)



0745-Z
DOUBLE ROBE HOOK, CHROME PLATED ZAMAK

DOUBLE
HOOK

Overall Dimensions:
2 3/16" x 1 7/16" x 1 29/64"
(56 x 37 x 37 mm)



0719
DOOR BUMPER, CHROME PLATED ZAMAK

WITH BUMPER

Overall Dimensions:
Chrome plated Zamac 2 3/16" (56 mm) diameter flange.
Projects 1 7/8" (48 mm).



1306
HEAVY-DUTY UTILITY HOOK, STAINLESS STEEL



TOILET TISSUE COMBINATION UNITS

Historically designed for disabled applications (ADA), as of late, particularly the horizontal combination units (picture on the left) have turned into a wider design trend.



**PARTITION
MOUNTED
COMBINATION
UNITS**



**RECESSED
COMBINATION
UNITS**



**WALL
MOUNTED
UNITS**



0487-R
RECESSED ADA-COMPLIANT TOILET TISSUE AND SEAT COVER DISPENSER WITH WASTE DISPOSAL

500	2	.45 gal.
SEAT COVER CAPACITY	TOILET PAPER CAPACITY (ROLLS)	WASTE CAPACITY (1.7 L)

Model Options:
0487-L All components on opposite side.
0487-R-9 Surface mounted with a stainless steel collar.
0487-L-9 Surface mounted with a stainless steel collar, with all components on opposite side.

Unit Size:
 28" x 14 1/4" x 4 1/4"
 (711 x 362 x 108 mm)

Wall Opening:
 26 1/2" x 12 7/8" x 4 1/4"
 (673 x 327 x 108 mm)



0482
RECESSED SEAT COVER AND TOILET TISSUE DISPENSER WITH SANITARY DISPOSAL

1,000	2	1.3 gal.
SEAT COVER CAPACITY	TOILET PAPER CAPACITY (ROLLS)	WASTE CAPACITY (4.9 L)

Model Options:
0482-R Toilet tissue and receptacle on opposite side.
0483 Surface mounted with a stainless steel collar.

Unit Size:
 17 7/8" x 30 5/8" x 4 1/4"
 (441 x 778 x 108 mm)

Partition Opening:
 15 1/2" x 28 7/8"
 (394 x 733 mm)
 adjustable for partitions in thickness
 from 1/2" to 2" (13 to 51 mm)



0481
PARTITION MOUNTED DUAL ACCESS SEAT COVER AND TOILET TISSUE DISPENSER WITH SANITARY DISPOSAL

1,000	4	1.3 gal.
SEAT COVER CAPACITY	TOILET PAPER CAPACITY (ROLLS)	WASTE CAPACITY (4.9 L)

Model Options:
0481-HC One side mounts flush.

Unit Size:
 17 7/8" x 30 5/8" x 4 1/4"
 (441 x 778 x 108 mm)

Partition Opening:
 15 1/2" x 28 7/8"
 (394 x 733 mm)
 adjustable for partitions in thickness
 from 1/2" to 2" (13 to 51 mm)



04813
PARTITION MOUNTED DUAL ACCESS TOILET TISSUE DISPENSER WITH NAPKIN DISPOSAL

4	1.3 gal.
TOILET PAPER CAPACITY (ROLLS)	WASTE CAPACITY (4.9 L)

Model Options:
04813-HC One side mounts flush.
04823 Holds two rolls, for end-stall installation.
04833 Surface mounted with a stainless steel collar.

Unit Size:
 17 7/8" x 20" x 4 1/4"
 (441 x 508 x 108 mm)

Partition Opening:
 15 1/2" x 18 1/4"
 (394 x 464 mm)
 adjustable for partitions in thickness
 from 1/2" to 2" (13 to 51 mm)



0484
PARTITION MOUNTED DUAL ACCESS
SEAT COVER DISPENSER

1,000

SEAT COVER
CAPACITY

4

TOILET PAPER
CAPACITY (ROLLS)

Model Options:

0484-HC Mounts flush to partition.

0484-HCR Dispenser on opposite side.

0484-R Dispenser on opposite side.

Unit Size:

17³/₈" x 30⁵/₈" x 4¹/₂"
 (441 x 778 x 114 mm)

Wall Opening:

15¹/₂" x 28⁷/₈" x 1/2" to 2"
 (394 x 733 x 13 to 51 mm)



0485
RECESSED SEAT COVER AND TOILET TISSUE DISPENSER

1,000

SEAT COVER
CAPACITY

2

TOILET PAPER
CAPACITY (ROLLS)

1.3 gal.

WASTE CAPACITY
(4.9 L)

Model Options:

0486 Surface mounted with a stainless steel collar.

Unit Size:

17³/₈" x 30⁵/₈" x 4¹/₂"
 (441 x 778 x 114 mm)

Wall Opening:

15³/₄" x 29" x 4"
 (400 x 737 x 102 mm)



04822
**RECESSED TOILET TISSUE DISPENSER/
 NAPKIN DISPOSAL**

2

TOILET PAPER
CAPACITY (ROLLS)

1.3 gal.

WASTE CAPACITY
(4.9 L)

Unit Size:

17¹/₄" x 12³/₄" x 4¹/₄"
 (438 x 324 x 108 mm)

Wall Opening:

15³/₄" x 11¹/₆" x 4"
 (400 x 283 x 102 mm)



048234
RECESSED MULTI-ROLL TOILET TISSUE DISPENSER

4

TOILET PAPER
CAPACITY (ROLLS)

Unit Size:

17³/₈" x 20" x 4¹/₄"
 (441 x 508 x 108 mm)

Wall Opening:

15³/₄" x 18³/₈" x 4"
 (400 x 467 x 102 mm)

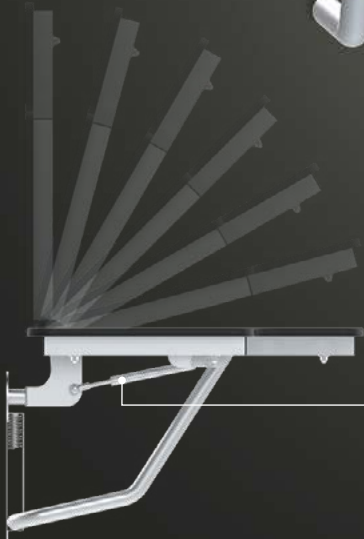

SLOW CLOSING FEATURE

SHOWER/TUB ACCESSORIES

A full range of shower and tub accessories that show attention to details.



SHOWER/TUB ACCESSORIES
ALL STAINLESS STEEL IS TYPE 304 WITH SATIN FINISH,
UNLESS OTHERWISE NOTED.



**SOAP
DISHES**



**SHOWER
CURTAIN
ROD**



**SHOWER
CURTAIN**



1204-2
EXTRA HEAVY-DUTY SHOWER CURTAIN ROD

SURFACE MOUNTED

Model Option:
1204-1 Flanges for shower curtain rod, end flanges.
1204-C Ceiling mounted shower rod support.
1214 20 gauge, 1" (25 mm) diameter rod. Available in lengths up to 72" (1829 mm).





1201-A
CURVED SHOWER CURTAIN ROD WITH MOUNTING BRACKETS AND FLANGES IN CHROME PLATED ZAMAK

CURVED ROD

Model Option:
1201-B Curved shower curtain rod with mounting brackets for opposite walls.
1201-41 Matte Black.



1224
CONCEALED MOUNTING SHOWER CURTAIN ROD WITH FLANGES IN CHROME PLATED BRASS

SURFACE MOUNTED

Model Option:
1224-C Ceiling mounted rod support.
1200-V White vinyl shower curtain.
1200-SHU Shower curtain hook.





0398
RECESSED HEAVY-DUTY SOAP DISH AND BAR

Model Options:
0399 Same as 0398, but includes kit for installing in cement wall.
0400 Without bar.
0401 Same as 0400, but includes kit for installing in cement wall.

Overall Dimensions:
 7 1/8" x 5" x 4"
 (181 x 127 x 102 mm)

Wall Opening:
 6 1/8" x 4 1/8" x 4"
 (156 x 105 x 102 mm)





7404-S
RECESSED SOAP DISH

Model Option:
7404-B Bright stainless steel.

Overall Dimensions:
 6 1/4" x 6 5/8" x 2"
 (159 x 160 x 51 mm)

Wall Opening:
 5 1/2" x 5 1/2" x 2"
 (140 x 140 x 51 mm)



7410-B
RECESSED SOAP DISH AND BAR

Model Option:
7410-S Satin stainless steel.

Overall Dimensions:
 6 7/16" x 6 1/4" x 3"
 (160 x 159 x 76 mm)

Wall Opening:
 5 1/2" x 5 1/2" x 2"
 (140 x 140 x 51 mm)



0721-Z
SOAP DISH

CHROME **SURFACE**
PLATED ZAMAC MOUNTED

Overall Dimensions:
4" x 1 1/2" x 3 1/4"
(102 x 38 x 83 mm)



0720-Z
SOAP DISH WITH DRAIN HOLES

CHROME **SURFACE**
PLATED ZAMAC MOUNTED

Overall Dimensions:
4" x 1 1/2" x 3 1/4"
(102 x 38 x 83 mm)



7320
SOAP DISH

SURFACE
MOUNTED

Model Options:
0721-Z Fabricated from triple chrome plated rust-resistant Zamac.
7320-B Bright stainless steel.
7320-S Satin stainless steel.

Overall Dimensions:
4 1/4" x 2" x 4"
(108 x 51 x 102 mm)



7335
TOOTHBRUSH AND TUMBLER HOLDER

SURFACE
MOUNTED

Model Options:
0735-Z Fabricated from triple chrome plated rust-resistant Zamac.
7335-B Bright stainless steel.
7335-S Satin stainless steel.

Overall Dimensions:
4 1/4" x 2" x 4"
(108 x 51 x 102 mm)



1200-SHU
SHOWER CURTAIN HOOK

.098"
DIAMETER

Overall Dimensions:
1 3/16" x 2 5/16"
(40 x 67 mm)



1200-V
VINYL SHOWER CURTAIN

ANTI-BACTERIAL



8203
COMPACT FOLDING SEAT

500 lbs. SOLID
SUPPORT LOAD PHENOLIC SEAT

Model Options:
8204 Seat is sponge cushion covered with off-white Naugahyde® mounted on 1/2" (13 mm) thick marine grade plywood.
8207 Seat is fabricated of stainless steel slats, satin finish.



8208-R
FOLDING SHOWER SEAT
FABRICATED STEEL SLATS,
SATIN FINISH

500 lbs.
SUPPORT LOAD

Model Option:
8208-L Left hand seat.



0010
CORNER SHOWER SEAT

300 lbs. CORNER
SUPPORT LOAD INSTALLATION

Overall Dimensions:
15 3/4" x 15 3/4"
(400 x 400 mm)



8358
FOLDING TUB SEAT

SOLID SURFACE
PHENOLIC SEAT MOUNTED



 **8206-L**
FOLDING SHOWER SEAT

500 lbs.
SUPPORT LOAD

SOLID
PHENOLIC SEAT

Model Options:
8206-R Right hand seat.
8205-L Left hand seat with cushion covered in off-white Naugahyde.
8205-R Right hand seat with cushion covered in off-white Naugahyde.



 **8206-SC-L**
SLOW CLOSE FOLDING SHOWER SEAT

500 lbs.
SUPPORT LOAD

SOLID
PHENOLIC SEAT

Model Option:
8206-SC-R Right hand seat.



 **8209**
RECTANGULAR PHENOLIC FOUR-LEG
FOLD-UP SHOWER BENCH

1250 lbs.
SUPPORT LOAD

WALL
MOUNTED /
FLOOR STANDING

SOLID
PHENOLIC SEAT



 **8202**
L-SHAPED PHENOLIC FOUR-LEG FOLD-UP SHOWER SEAT

1250 lbs.
SUPPORT LOAD

WALL
MOUNTED /
FLOOR STANDING

SOLID
PHENOLIC SEAT

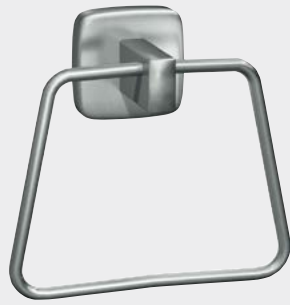

7385-S
TOWEL RING

SURFACE
MOUNTED

Model Options:
7385-41 Matte Black.
7385-B Bright stainless steel.



7306
TOWEL RING

SURFACE
MOUNTED



0760-Z
SQUARE TOWEL BAR

CHROME **SURFACE** **SQUARE**
PLATED ZAMAC MOUNTED STYLE



7360-S
SQUARE TOWEL BAR

SURFACE **SQUARE**
MOUNTED STYLE

Model Option:
7360-B Bright finish.



7380-S
SQUARE TOWEL BAR

SURFACE **SQUARE**
MOUNTED STYLE

Model Option:
7380-B Bright finish.



7355
TOWEL BAR-ROUND

SURFACE **ROUND**
MOUNTED STYLE

Model Options:
7355-24-41 24" Matte Black.
7355-B Bright stainless steel.
7355-S Satin stainless steel.



0755-SS
HEAVY-DUTY STAINLESS STEEL TOWEL BAR

SURFACE **ROUND**
MOUNTED STYLE

Model Option:
0755-Z Triple chrome plated rust proof Zamac brackets.
Triple chrome plated steel tubing.



7307-18
ROUND TOWEL BAR

SURFACE **ROUND**
MOUNTED STYLE

Model Option:
7307-24 Same as 7307-18, but 24"
(610 mm) in length, 5/8" (16 mm) DIA.



7311-B
TOWEL SHELF WITH TOWEL BAR

SURFACE
MOUNTED



DETAILS



MINIMALISTIC, CONTEMPORARY, AND CLASSIC

Timeless design put into machined precision.

LEED® FRIENDLY

LEED®-FRIENDLY

The robust construction made of type 304 stainless steel is LEED®-friendly and fits our sensibility about longer lifecycle building designs.



HUMBLE LOOK, RICH FUNCTION

Withdrawn impressions for sleek complementation.

HOSPITALITY ACCESSORIES

A wide range of towel bars and racks, clothes hooks, shelving, holders, and many more for the hospitality sector.

HOSPITALITY ACCESSORIES
ALL STAINLESS STEEL IS TYPE 304 WITH SATIN FINISH,
UNLESS OTHERWISE NOTED.



**SINGLE
TOILET
PAPER
ROLL
HOLDER**



**SHELF
WITH
HANGER
ROD**

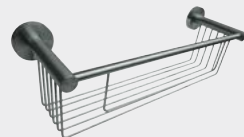

**SUNDRIES
SHELF**



7308
SINGLE ROBE HOOK

SINGLE
HOOK



7312
DOUBLE ROBE HOOK

DOUBLE
HOOK





7314
SINGLE TOILET PAPER
ROLL HOLDER

SURFACE
MOUNTED

Overall Dimensions:
5⁷/₁₆" x 3³/₈" x 2³/₁₆"
(131 x 86 x 56 mm)



7317
COVERED WASTE RECEPTACLE

2.0 gal. **FLOOR**
WASTE CAPACITY **STANDING**
(7.6 L)

Model Option:
7317-S Satin stainless steel finish.

Overall Dimensions:
8⁷/₃₂" DIA x 12³/₄"
(210 DIA x 324 mm)



7387
SURFACE MOUNTED TOILET BRUSH AND HOLDER

WALL
MOUNTED



0712
SURFACE-MOUNTED RETRACTABLE CLOTHES LINE, BRIGHT FINISH

72" **RETRACTABLE**
VINYL COVERED
CORD



7383
SURFACE MOUNTED TOWEL SHELF WITH HANGER ROD

35.3 lb.
WEIGHT CAPACITY

Overall Dimensions:
23³/₈" x 3¹/₂" x 8¹⁹/₁₆"
(600 x 89 x 227 mm)



7381
SURFACE MOUNTED SUNDRIES SHELF

11 lb.
WEIGHT CAPACITY

Overall Dimensions:
12¹/₈" x 4⁷/₁₆" x 3³⁹/₆₄"
(372 x 114 x 90 mm)



7306
TOWEL RING

SURFACE
MOUNTED





0785-Z
TOWEL RING, ZAMAK

SURFACE
MOUNTED

Overall Dimensions:
6³/₈" x 1⁵/₈"
(162 x 41 mm)



7322
SURFACE MOUNTED SOAP BASKET

10 lb.
WEIGHT CAPACITY

Overall Dimensions:
11¹⁹/₃₂" x 2⁹/₃₂" x 6¹/₂"
(291 x 58 x 165 mm)



7307-18
ROUND TOWEL BAR

SURFACE
MOUNTED

Model Option:
7307-24 Same as 7307-18, but 24"
(610 mm) in length, 5/8" (16 mm) DIA.

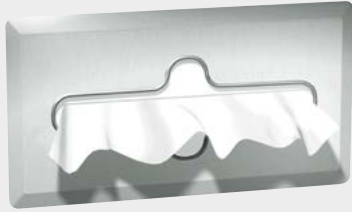

0259-SS
RECESSED FACIAL TISSUE DISPENSER, SATIN FINISH

SMOOTH
 DISPENSING
 SLOT

Model Option:
0259-B Bright stainless steel.

Overall Dimensions:
 11¹/₈" x 6³/₈" x 2¹/₄"
 (302 x 162 x 57 mm)



0258-SS
SURFACE MOUNTED FACIAL TISSUE DISPENSER

Overall Dimensions:
 10¹/₄" x 5⁵/₁₆" x 2³/₁₆"
 (260 x 135 x 55 mm)



1201-A
**CURVED SHOWER CURTAIN ROD WITH MOUNTING
 BRACKETS AND FLANGES IN CHROME PLATED ZAMAK**

CURVED **WALL**
 ROD MOUNTED

Model Option:
1201-B Curved shower curtain rod with mounting brackets
 for opposite walls.
1201-41 Matte Black.

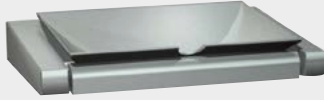

8091
ASH TRAY (FLIP-TYPE)

SURFACE
MOUNTED

Overall Dimensions:
4³/₄" x 3³/₄" x 1¹/₄"
(120 x 90 x 32 mm)



0711-B
BOTTLE OPENER

SURFACE
MOUNTED

Overall Dimensions:
2" x 2¹/₄" x 1¹/₁₆"
(51 x 57 x 27 mm)



0002-SM
STAINLESS STEEL PAPER CUP DISPENSER, BRIGHT FINISH

SURFACE
MOUNTED

Overall Dimensions:
3" Diameter x 15"
(76 x 381 mm)

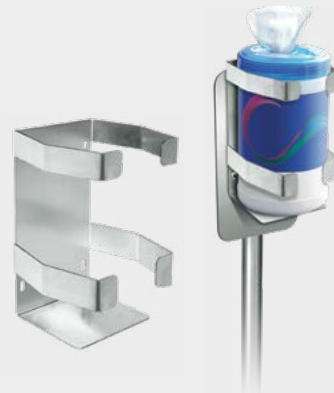

0502
WALL MOUNTED WIPES DISPENSER HOLDER,
SATIN FINISH

MANUAL
DISPENSING

Overall Dimensions:
5²⁹/₆₄" x 8" x 5"
(139 x 203 x 127 mm)



DETAILS



ADA ACCESSIBILITY STANDARD COMPLIANT

Our healthcare accessories are engineered to comply with the standards set forth by the Americans with Disabilities Act for accessibility and safety.



CYLINDER LOCK

The design of our cylinder locks allows for the removal of the cylinder for sterilizing or autoclaving when necessary.



CONVENIENT PASSAGE

Our specimen pass box and cabinet enables easy access and safe handling of specimens from patient area to laboratory.



ADJUSTABLE SHELVES

The design of our cabinets offers flexibility with adjustable shelves for ease in storage and use.

HEALTHCARE ACCESSORIES

From grab bars and a slow close shower seat to glove dispensers, security cabinets, and hazardous waste disposals.



**RECESSED
STAINLESS
STEEL MEDICINE
CABINET**



**RECESSED
SHARPS
DISPOSAL
CABINET**



**TURNTABLE
SPECIMEN
PASS BOX**



0952

RECESSED STAINLESS STEEL MEDICINE CABINET

ADJUSTABLE

SHELVES

Overall Dimensions:

18¼" x 24¼" x 4½"
(464 x 616 x 114 mm)

Wall Opening:

16" x 22¾" x 3½"
(406 x 578 x 89 mm)

Model Option:

0952-B Larger than 0952.

Overall Dimensions:

24" x 26" x 4⅞"
(610 x 660 x 124 mm)

Wall Opening:

21¾" x 24½" x 3½"
(550 x 620 x 89 mm)



0953

SURFACE MOUNTED STAINLESS STEEL MEDICINE CABINET

ADJUSTABLE

SHELVES

Overall Dimensions:

18¼" x 24¼" x 4¾"
(464 x 616 x 121 mm)

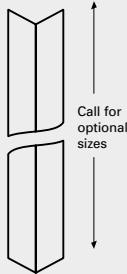

0533 SERIES

CORNER GUARD

SURFACE

MOUNTED

1) CHOOSE EDGE AND MOUNTING STYLE:

0533-1 Beveled w/ Adhesive 0533-3 Straight w/ Adhesive
0533-2 Beveled w/ Mounting Holes 0533-4 Straight w/ Mounting Holes

2) ADD PREFIX FOR GAUGE:

1 (16 Gauge) or 2 (18 Gauge)
Ex: 0533-3-2 straight edges with adhesive mounting, 18 gauge

Overall Dimensions:

48" x 4¼" x 4¼" (1219 x 108 x 108 mm)

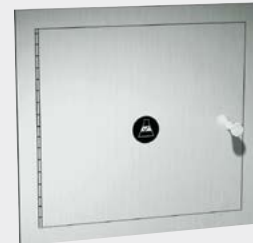

8154

RECESSED PASS-THROUGH SPECIMEN CABINET

CYLINDER

LOCK

Model Options:

8155 Extension sleeve and flange for recessed specimen pass-through cabinet.

8156 Same as 8154 including 8155 extension sleeve.



8340
**RECESSED MEDICINE CABINET, POWDER COATED STEEL,
 MIRROR FRAME STAINLESS STEEL**

1/4" ADJUSTABLE
 PLATE GLASS SHELVES

Overall Dimensions: 18 1/4" x 24 1/4" x 4 7/8"
 (465 x 615 x 120 mm)
Wall Opening: 16" x 22 3/4" x 3 1/2"
 (406 x 578 x 89 mm)

Model Options:
8338 Smaller and has two adjustable white baked enamel steel shelves.

Overall Dimensions: 14 1/8" x 20 3/16" x 5"
 (359 x 513 x 125 mm)
8339 Larger than 8338.
 16 7/16" x 22 7/16" x 5"
 (411 x 564 x 127 mm)



0515
TURNTABLE SPECIMEN PASS BOX

RECESSED CYLINDER
 LOCK



0350
**SURGICAL SOAP DISPENSER,
 CHROME PLATED BRASS BRACKET**

16 oz. SURFACE
 CAPACITY MOUNTED

Overall Dimensions:
 3 3/8" x 6 1/2" x 5 1/8"
 (86 x 165 x 130 mm)



0349
**FOOT OPERATED SURGICAL SOAP DISPENSER,
 TYPE 316 STAINLESS STEEL SPOUT**

32 oz. SURFACE FOOT
 CAPACITY MOUNTED OPERATED

Overall Dimensions: 4 1/4" x 12 3/4" x 9"
 (108 x 324 x 229 mm)
Spout Projection:
 9" (229 mm) from wall



0815
**FLOOR STANDING FOOT
OPERATED WASTE RECEPTACLE**

8 gal. **FOOT**
WASTE CAPACITY OPERATED
(30.7 L)

Overall Dimensions:
10³/₄" x 20¹⁵/₁₆" x 10"
(273 x 531 x 254 mm)



0548
**RECESSED SHARPS DISPOSAL
CABINET**

Model Option:
0548-9 Surface mounted with a
stainless steel collar.

Overall Dimensions:
13³/₄" x 19¹/₁₆" x 5¹/₄"
(349 x 486 x 133 mm)

Wall Opening:
12¹/₈" x 17³/₄" x 5"
(308 x 451 x 127 mm)



0551
**RECESSED BEDPAN AND URINAL
BOTTLE CABINET**

ADJUSTABLE
SHELVES

Model Option:
0558-1 Recessed bedpan and wash
basin cabinet.

Overall Dimensions:
15" x 28" x 5¹/₄"
(381 x 711 x 133 mm)

Wall Opening:
13³/₈" x 26¹/₂" x 5³/₈"
(340 x 670 x 140 mm)



0501-X
SURFACE MOUNTED SURGICAL GLOVE DISPENSER

SNAG-FREE
DISPENSING

Model Options:

- 0501-1** Dispenser for 1 box.
- 0501-2** Dispenser for 2 boxes.
- 0501-3** Dispenser for 3 boxes.
- 0501-4** Dispenser for 4 boxes.



0511
SURFACE MOUNTED BULK DISPENSER, SMALL

SMALL
FOOTPRINT

Overall Dimensions:
12⁵/₆₄" x 11" x 5¹/₂"
(307 x 279 x 140 mm)

Model Option:
0512 Large bulk dispenser.

Overall Dimensions:
12⁵/₆₄" x 17" x 5¹/₂"
(307 x 431 x 140 mm)



0557
SURFACE MOUNTED BEDPAN RACK

Model Options:

- 0556** Surface mounted bedpan and urinal rack.
- 0559** Surface mounted double bedpan rack. Similar to 0556 but designed to hold two conventional sized bedpans.

Overall Dimensions:
12" x 11" x 4⁷/₈"
(305 x 279 x 124 mm)



0198-MH
SAFE-DRI™ MENTAL HEALTH APPROVED RECESSED
HIGH-SPEED HAND DRYER

66 dBA **ANTI-**
NOISE LEVEL **LIGATURE**

Noise Level:
66 dBA

Unit Size:
12⁵/₆₄" x 15³/₄" x 5¹/₁₆"
(320 x 400 x 140 mm)

Wall Opening:
12¹/₄" x 15³/₁₆" x 5¹/₄"
(311 x 386 x 133 mm)





CUSTODIAL ACCESSORIES

Our one-piece constructed custodial accessories—with various configurations of mop and broom holders and utility hooks.



**UTILITY
HOOKS**



1307-3
UTILITY HOOK STRIP
WITH 3 HOOKS

SURFACE
MOUNTED

Model Options:
1307-4 With 4 hooks 36"
(914 mm) long.
1307-5 With 5 hooks 46"
(1168 mm) long.
1307-6 With 6 hooks 56"
(1422 mm) long.



1308-3
SHELF WITH 4 UTILITY HOOKS
AND 3 MOP HOLDERS STRIP

SURFACE
MOUNTED

Model Option:
1308-4 4 mop holders/5 utility
hooks, 44" (1118 mm) long.



1306
HEAVY-DUTY UTILITY HOOK

SURFACE
MOUNTED

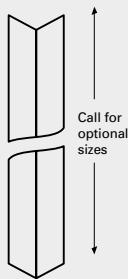

0533 SERIES
CORNER GUARD

SURFACE
MOUNTED

1) CHOOSE EDGE AND MOUNTING STYLE:

- 0533-1 Beveled w/ Adhesive
- 0533-2 Beveled w/ Mounting Holes
- 0533-3 Straight w/ Adhesive
- 0533-4 Straight w/ Mounting Holes

2) ADD PREFIX FOR GAUGE:

- 1 (16 Gauge) or 2 (18 Gauge)
- Ex: 0533-3-2 straight edges with adhesive mounting, 18 gauge

Overall Dimensions:
48" x 4 1/4" x 4 1/4"
(1219 x 108 x 108 mm)



8215-5
MOP AND BROOM RACKS

SURFACE
MOUNTED

Model Options:
8215-3 3 holders, 26" (660 mm) long.
8215-4 4 holders, 36" (914 mm) long.



1315-4
UTILITY SHELF WITH DRYING ROD, 4 MOP HOLDERS, AND 3 RAG HOOKS

SURFACE
MOUNTED

Model Options:
1315-3 3 mop holders/2 rag hooks, 30" (762 mm) long.
1315-6 6 mop holders/5 rag hooks, 48" (1219 mm) long.



SECURITY ACCESSORIES

For settings with high security requirements. Features include design for contraband detection and clothes hooks that release when excessively loaded to deter self-harm actions.

SECURITY ACCESSORIES
ALL STAINLESS STEEL IS TYPE 304 WITH SATIN FINISH,
UNLESS OTHERWISE NOTED.



**HAND
DRYERS**



MIRRORS



**CLOTHES
HOOKS**



0198-MH
SAFE-DRI™ MENTAL HEALTH
RECESSED HIGH-SPEED
HAND DRYER

66 dBA
NOISE LEVEL

ANTI-
LIGATURE

Noise Level:
66 dBA

Unit Size:
12⁵/₈" x 15³/₄" x 5¹/₁₆"
(320 x 400 x 140 mm)

Wall Opening:
12¹/₄" x 15³/₁₆" x 5¹/₄"
(311 x 386 x 133 mm)



128-1
BOOK SHELF/CLOTHES HOOK –
FRONT MOUNT

ANTI-
LIGATURE

Overall Dimensions:
18" x 11" x 8"
(457 x 279 x 203 mm)



120
CLOTHES HOOK – FRONT MOUNT

ANTI-
LIGATURE

Overall Dimensions:
3" x 5" x 3¹/₁₆"
(76 x 127 x 78 mm)

Special "closure plate" for security applications

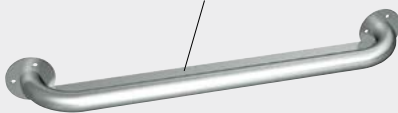

165
GRAB BAR

ANTI-
LIGATURE

MODEL OPTIONS:

Front Mounted	Length
159	18" (457)
162	30" (762)
164	36" (914)
165	24" (610)
167	42" (1067)
169	48" (1219)



110-1
SQUARE RECESSED TOILET
TISSUE HOLDER – REAR MOUNT

1
TOILET PAPER
CAPACITY (ROLLS)

Model Option:
110-13 Front mounted holder.



123
SQUARE CLOTHES HOOK–
FRONT MOUNT

ANTI-
LIGATURE

Overall Dimensions:
4¹/₄" x 4¹/₄" x 2¹/₄"
(108 x 108 x 57 mm)



101-14
SECURITY FRAMED MIRROR –
CHASE MOUNT

15 YEAR
WARRANTY

Overall Dimensions:
 12" x 16" x 5/8"
 (305 x 406 x 16 mm)



105-14
SECURITY FRAMED MIRROR –
FRONT MOUNT

15 YEAR
WARRANTY

Overall Dimensions:
 12" x 16" x 5/8"
 (305 x 406 x 16 mm)

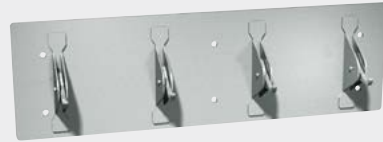

127
CLOTHES/TOWEL HOOK STRIP –
FRONT MOUNT

ANTI-
LIGATURE

Overall Dimensions:
 18" x 5 1/2" x 3"
 (457 x 140 x 76 mm)



129
CLOTHES/TOWEL HOOK STRIP –
FRONT MOUNT

ANTI-
LIGATURE

Overall Dimensions:
 18" x 5 1/2" x 2 1/4"
 (457 x 140 x 57 mm)



140
RECESSED SOAP DISH–
REAR MOUNT

Overall Dimensions:
 7 3/8" x 6" x 3"
 (187 x 152 x 76 mm)

Wall Opening:
 6 1/2" x 5 x 3" min
 (165 x 127 x 76 mm)



130
RECESSED SHELF – REAR MOUNT

Overall Dimensions:
 18" x 7" x 4"
 (457 x 178 x 102 mm)

Wall Opening:
 5 1/2" x 16 1/2"
 (141 x 419 mm)

WHO WE ARE

ASI Group designs, engineers, and manufactures fully integrated washroom accessories, partitions, lockers, and visual display products from one source.

Our family of companies work together with one mission in mind—“To make our customers successful by providing value that exceeds price and an excellent service experience.”

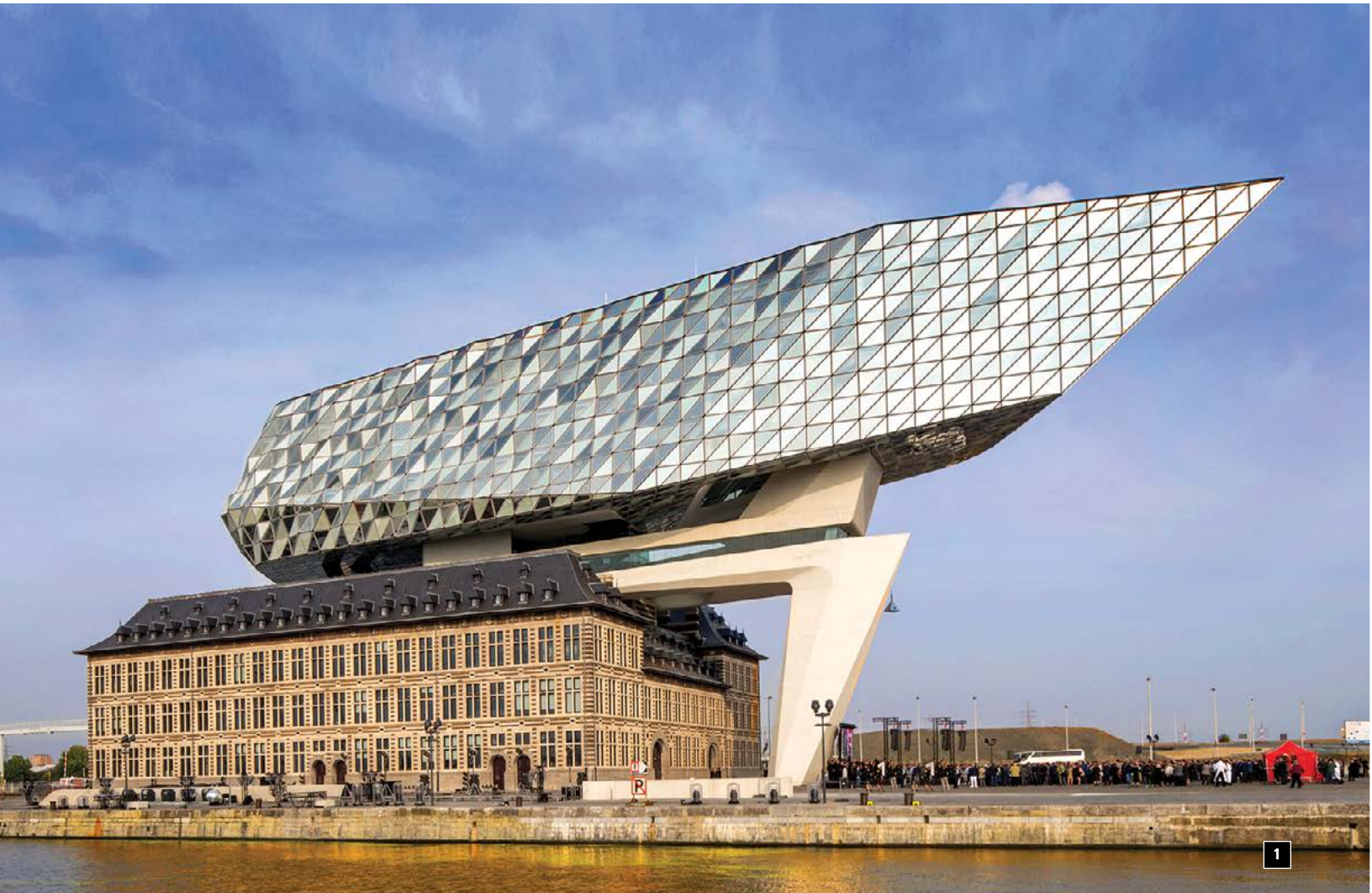

1 **Port House**
Architect: Zaha Hadid Architects
ASI Alpaco™ Partitions



2 **U.S. Bank Stadium**
Architect: HKS
Washroom Accessories and
Solid Plastic Partitions





**WE ARE LASER FOCUSED ON DELIVERING EXACTLY WHAT YOU NEED—
WHERE AND WHEN YOU NEED IT.**

Operating units and offices in the USA, Canada, Australia, Europe, Middle East, China, and Mexico, along with sales in more than 50 countries.

Our broad scope helps meet the needs of healthcare, education, office, and retail buildings, as well as airports, stadiums, government offices, cultural centers, and hotel/restaurant operations.

SALES IN OVER 50 COUNTRIES

385+ DOMESTIC AND INTERNATIONAL SALES REPRESENTATIVES

1,000+ HIGHLY SKILLED EMPLOYEES

>1.3 MILLION SQ. FT. MANUFACTURING & OFFICE FACILITIES



2



3



4

3 **New York-Presbyterian David H. Koch Center**
Architect: HOK Architects
HDPE Plastic Z lockers, Phenolic Z lockers, Metal Z lockers, and Stainless Steel Accessories and Partitions



4 **Perimeter College**
Architect: Teeple Architects
ASI Visual Display Products



PAPER TOWEL DISPENSERS

Model	Page
0210	36/52
0210-41	36/42/44/52
0215	37/56
0245-SS	37/56
0439	36/57
0452	36/53
0452-9	36/53
045210A	39/55
045210A-6	39/55
045210A-9	39/55
045210AC	39/55
045210A-6	39/55
045210A-9	39/55
0457	36/53
0457-2	53
0457-9	36/53
1002	37/56
1005	56
20210	27/52
20452	28/50/54
204523A	30/55
204523A-6	30/55
204523A-9	30/55
204523AC	30/55
204523A-6	30/55
204523A-9	30/55
6452	19/52
6452-9	19/52
645210A	11/20/54
645210A-6	20/54
645210A-9	20/54
645210A-00	11/54
645210A-41	11/54
645210AC	11/20/54
645210AC-6	20/54
645210AC-9	20/54
645210AC-00	11/53/54
645210AC-41	11/53/54
645224A	55
645224A-6	21/55
645224A-9	21/55
645224AC	21/55
645224AC-6	21/55
645224AC-9	21/55
6457	10/19/52
6457-00	53
6457-41	53
68523A	21/54
68523A-4	21/54
68523AC	21/54
68523AC-4	21/54
8165	40/57
8370	57
8374	57
8522	40/57

8523A	38/40/55/57
8523AC	38/40/55/57
8523A	38/40/55/57
8523AC	38/40/55/57
8524	55

SOAP, FOAM, AND SANITIZER DISPENSERS

Model	Page
0326	22/64
0332	63
0332-C	63
0332-CD	63
0332-D	63
0334-B	61
0334-S	61
0335-B	61
0335-S	61
0336	63
0338	63
0339	63
0341	64
0345	45/65
0345-41	45/65
0347	45/65
0347-41	45/65
0357	65
0359	65
0360	62
0361	62
0362	62
0362-41	45/58/62
0387	59/61
0390	59
0390-(N)	59/60
0391-(N)	60
0391-(N)-41	60
0391-1A	60
0391-1AC	60
0391-6-1A	60
0391-6-1AC	60
0393-(N)	60
0394-(N)	60
0397	59/62
0397-1A	60
0397-1A-41	60
0397-1AC	60
0397-1AC-41	46/59/60
0502	143
20334	62
20363	27/62
20364	27/62
20365	27/62
5001-SS	64
9343	27/64
9343-41	27/46/64

WASTE RECEPTACLES

Model	Page
0458	41/69
0458-9	41/69
04733	41/71
0815	68/148
0825	40/70
0826	40/70
0827	40/70
0828	40/70
0829	41/69
0834	41/68
0834-RB	68
0834-T	41/68
0839	41/68
0839-RB	68
0839-T	41/68
1000	41/68
1000A	41/68
1003	40/68
20458	28/70
20826	27/69
20826-T	27/69
6474	20/66/71
6474-41PC	20/46/71
6474-2	20/71
6474-2-41PC	20/46/71
6474-00	10/71
6459	19/71
7317	69/138
7317-S	69/138

AUTOMATIC HAND DRYERS

Model	Page
0135-1	23/75
0135-2	23/75
0184	75
0185	75
0185-00	75
0185-92	75
0185-93	75
0192-1-93	74
0192-1-41	74
0192-2-93	74
0196-1-00	72/74
0196-1-41	46/72/74
0196-1-93	72/74
0196-2-00	74
0196-2-41	74
0196-2-93	74
0197-1	74
0197-2-93	74
0198-MH	75/149/156
0199-1-00	74
0199-1-93	74
0199-1-41	46/74
0199-2-00	74

0199-2-41	74
0199-2-93	74
20199	31/75

MIRRORS/CABINETS

Model	Page
0535	79
0600	78/79
0600-41	46/79
0600-T	78/79
0605	78/79
0620	78/79
0625	78/79
0640	78/139
0641	78/139
0952	81/146
0952-B	81/146
0953	81/144/146
20650	31/78/79
20650-B	78/79
20655	31/78/79
8026	80
8287	80
8338	81/147
8339	81/147
8340	81/147

BABY CHANGING STATIONS

Model	Page
9012	84
9013	87
9013-9	87
9014	84
9014-41	47/84
9015	84
9017	86
9017-9	86
9018	87
9018-41	47/86
9018-9	87
9018-9-41	86
9020	85
9022	85
9024-41	85
9026-41	85

SHELVES

Model	Page
0412	91
0690	90
0692	90/91
0692-5xx	90/91
0692-6xx	90/91
0692-8xx	90/91
0694	90/91
0698	91
20692	31/88/90/91

FEMININE HYGIENE VENDORS

Model	Page
0464	94
0468	92/95
0468-2	95
04684	95
0864	94
204684	31/95
204684-9	31/95
6468	23/94
64684	23/94

TOILET TISSUE DISPENSERS

Model	Page
0030	98/105
0030-41	48/98
0031	98
0032	98
0039	99
0040	99
0042	99
0042-41	42/48/99
0046	99
0263-1	103
0263-1A	103
0264-1	103/104
0264-12	103
0264-1A	103
0264-1A2	103
0266	104
0267	104
048234	103/127
0697-GAL	102
0705-Z	102
0710	103
0715	103
20030	30/98
20031	30/98
7303-B	104
7303-S	104
7305-B	101
7305-S	101
7305-41	48/101
7305-2B	102
7305-2-41	48/102
7305-2S	102
7314	102/138
7314-H	102/139
7316	102/139
7402-BSM	100
7402-B	100
7402-HB	100
7402-HS	100
7402-SSM	100
7402-S	100
7402-HBSM	100
7402-HSSM	100
74022-BSM	101
74022-B	101

74022-HBSM	101
74022-HSSM	101
74022-HS	101
74022-SSM	101
74022-S	101
7403-B	101
7403-S	101
8010	103
8020	104
R-002	104
R-003	105
R-004	105
R-005	105
R-009	105

TOILET SEAT COVER DISPENSERS

Model	Page
0477	108
0477-SM	108
0477-SM-41	49/108
20477-SM	30/109
6477	23/106/109
6477-9	109

HYGIENE DISPOSALS

Model	Page
0472	112
0472-1	112
0473	112
0473-1	112
0473-A	112
0473-1A	110/112
0852	113
6471	23/113
20470	30/113
20852	30/113

GRAB BARS

Model	Page
3400/3500	115
3700/3800	115
3700-W	115
3800-W	115
3801-41	48/115
3801-18-41	48/115
3801-24-41	48/115
3801-36-41	48/115
3801-42-41	48/115
7801	115
7801-18	115
7801-24	115
7801-36	115
7801-42	115

HOOKS

Model	Page
0714	122
0719	123

0740-Z	123
0745-Z	123
0751	122
0751-A	122
7301-B	121
7301-S	121
1306	123/152
7308	118/120/138
7312	118/120/138
7340-41	49/120
7340-B	120
7340-S	120
7345-B	121
7345-S	121
7382-B	121
7382-S	121
8425	122

TOILET TISSUE COMBINATION UNITS

Model	Page
0481	127
0481-HC	127
04813	126
04813-HC	126
0482	126
0482-R	126
04822	127
04823	126
048234	103/127
04833	126
0483	126
0484	127
0484-HC	127
0484-HCR	127
0484-R	127
0485	127
0486	127
0487-R	124/126
0487-L	126
0487-R-9	126
0487-L-9	126

SHOWER/TUB ACCESSORIES

Model	Page
0010	132
0398	130
0399	130
0400	130
0401	130
0720-Z	131
0721-Z	131
0735-Z	131
0755-SS	135
0755-Z	135
0760-Z	134
1200-SHU	130/132

1200-V	130/132
1201-A	130
1201-B	130
1201-41	130
1204-1	130
1204-2	130
1204-C	130
1214	130
1224	130
1224-C	130
7306	134/141
7307-18	135/141
7307-24	135/141
7311-B	135
7320	131
7320-B	131
7320-S	131
7335	131
7335-B	131
7335-S	131
7355	135
7355-24-41	49/135
7355-B	135
7355-S	135
7360-B	134
7360-S	134
7380-B	134
7380-S	134
7385-41	49/134
7385-B	134
7385-S	134
7404-B	130
7404-S	130
7410-B	130
7410-S	130
8202	133
8203	132
8204	132
8205-R	133
8205-L	133
8206-R	133
8206-L	133
8206-SC-R	133
8206-SC-L	133
8207	132
8208-R	132
8208-L	132
8209	133
8358	132

HOSPITALITY ACCESSORIES

Model	Page
0002-SM	143
0258-SS	142
0259-SS	142
0259-B	141
0502	65/143

0640	78/139
0640-2436	139
0640-3036	139
0640-4836	139
0640-6036	139
0641	78/139
0641-2436	139
0641-3036	139
0641-4836	139
0641-6036	139
0711-B	143
0712	140
0785-Z	141
1201-A	128/130/142
1201-B	130/142
1201-41	142
7306	134/141
7307-18	135/141
7307-24	135/141
7308	118/120/138
7312	118/120/138
7314	102/138
7314-H	102/139
7316	103/139
7317	69/138
7317-S	69/138
7322	141
7355-24-41	19/135
7381	140
7383	140
7387	140
8091	143

HEALTHCARE ACCESSORIES

Model	Page
0198-MH	75/149/156
0349	147
0350	147
0501-X	149
0501-1	149
0501-2	149
0501-3	149
0501-4	144/149
0511	149
0512	149
0515	147
0533 SERIES	144/146/153
0533-1	146/153
0533-2	146/153
0533-3	146/153
0533-4	146/153
0548	148
0548-9	148
0551	148
0556	149
0557	149
0558-1	149
0559	149
0815	68/148
0952	81/146
0952-B	81/146
0953	81/144/146
8154	146

8155	146
8156	146
8338	81/147
8339	81/147
8340	81/147

CUSTODIAL ACCESSORIES

Model	Page
0533 SERIES	146/149/153
0533-1	146/153
0533-2	146/153
0533-3	146/153
0533-4	146/153
1306	123/152
1307-3	150/152
1307-4	152
1307-5	152
1307-6	152
1308-3	152
1308-4	152
1315-4	153
1315-3	153
1315-6	153
8215-3	153
8215-4	153
8215-5	153

SECURITY ACCESSORIES

Model	Page
0198-MH	75/149/156
101-14	157
105-14	157
110-1	156
110-13	156
120	156
123	156
127	157
128-1	156
129	157
130	157
140	157
159	156
162	156
164	156
165	156
167	156
169	156

INDEX OF PRODUCTS BY MODEL NUMBER

MODEL	PAGE	MODEL	PAGE	MODEL	PAGE	MODEL	PAGE	MODEL	PAGE
0002-SM	143	0339	63	0397-41	59	0472-1	112	0640-4836	139
0010	132	0341	64	0397-1A	59/60	0473	112	0640-6036	139
0030	98/105	0345	45/65	0397-1AC	58/59	0473-1	112	0641	78/139
0030-41	48/98	0345-41	45/65	0397-1A-41	59/60	0473-A	112	0641-2436	139
0031	98	0347	45/65	0397-1AC-41	46/59/60	0473-1A	110/112	0641-3036	139
0032	98	0347-41	45/65	0398	130	04733	41/71	0641-4836	139
0039	99	0349	147	0399	130	0477	108	0641-6036	139
0040	99	0350	147	0400	130	0477-SM	108	0661-1	14
0042	99	0357	65	0401	130	0477-SM-41	49/108	0661-2	14
0042-41	42/48/99	0359	65	0412	91	0481	127	0661-T	12/14
0046	99	0360	62	0439	36/57	0481-HC	127	0661-FM-14	14
0135-1	23/75	0361	62	0452	36/53	04813	126	0661-FM-23	14
0135-2	23/75	0362	62	0452-9	36/53	04813-HC	126	0663-1	15
0184	75	0362-41	45/58/62	045210A	39/55	0482	126	0663-2	15
0185	75	0387	59/61	045210A-6	39/55	0482-R	126	0663-T	15
0185-00	75	0388	59	045210A-9	39/55	04822	127	0690	90
0185-92	75	0388-1A	59	045210AC	39/55	04823	126	0692	90/91
0185-93	75	0388-1AC	59	045210AC-6	39/55	048234	103/127	0692-5xx	90/91
0192-1-93	74	0389	59	045210AC-9	39/55	0483	126	0692-6xx	90/91
0192-1-41	74	0389-1A	59	0457	36/53	04833	126	0692-8xx	90/91
0192-2-93	74	0389-1AC	58/59	0457-2	53	0484	127	0694	90/91
01961-1-00	72/74	0390-(N)	60	0457-9	36/53	0484-HC	127	0697-GAL	102
0196-1-41	46/72/74	0390	59	0458	41/69	0484-HCR	127	0698	91
0196-1-93	72/74	0390-1A	59	0458-9	41/69	0484-R	127	0705-Z	102
0196-1-41	46/74	0390-1A-41	59	0458-DX	41/69	0485	127	0710	103
0196-2-00	74	0390-1AC	59	0458-CX	41/69	0486	127	0711-B	143
0196-2-41	46/74	0390-1AC-41	59	0462-AD	34	0487-L	126	0712	140
0196-2-93	74	0390-6-1A	59	0462-AD-9	34	0487-L-9	126	0714	122
0197-1	74	0390-6-1A-41	59	0464	94	0487-R	124/126	0715	103
0197-2-93	74	0390-6-1AC	59	0467	35	0487-R-9	126	0719	123
0198-MH	75/149/156	0390-6-1AC-41	59	0467-2	35	0501-X	149	0720-Z	131
0199-1-00	74	0390-ARK	59	0467-9	35	0501-1	149	0721-Z	131
0199-1-41	46/74	0390-BR	59	0468	92/95	0501-2	149	0735-Z	131
0199-1-93	74	0390-R	59	0468-2	95	0501-3	149	0740-Z	123
0199-2-00	74	0390-(N)	60	04684	95	0501-4	144/149	0745-Z	123
0199-2-41	74	0391-(N)	60	0469	34	0502	143	0751	122
0199-2-93	74	0391-(N)-41	60	0469-2	34	0511	149	0751-A	122
0210	36/52	0391-1A	59/60	0469-9	34	0512	149	0755-SS	135
0210-41	36/42/44/52	0391-1A-41	59	0469-BL	34	0515	147	0755-Z	135
0215	37/56	0391-1AC	59/60	04692-6	38	0533-1	146/153	0760-Z	134
0245-SS	37/56	0391-1AC-41	59	04692-9	38	0533-2	146/153	0785-Z	141
0258-SS	142	0391-6-1A	59/60	04692	38	0533-3	146/153	0815	68/148
0259-SS	142	0391-6-1A-41	59	04692A	38	0533-4	146/153	0825	40/70
0259-B	141	0391-6-1AC	59/60	04692A-6	38	0533 SERIES	144/146/153	0826	40/70
0263	104	0391-6-1AC-41	59	04692A-9	38	0535	78/79	0827	40/70
0263-1	104	0393-(N)	60	04692AC	38	0537	78	0828	40/70
0263-1A	104	0393-1A	59	04692AC-6	38	0548	148	0829	41/69
0264	104	0393-1A-41	59	04692AC-9	38	0548-9	148	0834	41/68
0264-1	103/104	0393-1AC	59	046921	38	0551	148	0834-RB	68
0264-12	103	0393-1AC-41	59	046921-6	38	0556	149	0834-T	41/68
0264-1A	103	0393-6-1A	59	046921-9	38	0557	149	0839	41/68
0264-1A2	103	0393-6-1A-41	59	046921A	38	0558-1	149	0839-41	47
0266	104	0393-6-1AC	59	046921A-6	38	0559	149	0839-RB	68
0267	104	0393-6-1AC-41	59	046921A-9	38	0600	78/79	0839-T	41/68
0326	22/64	0393-R	59	046921AC	38	0600-T	78/79	0852	113
0332	63	0394-(N)	60	046921AC-6	38	0600-1836-41	46	0852-41	49
0332-C	63	0394-1A	59	046921AC-9	38	0600-2436-41	46	0864	94
0332-CD	63	0394-1A-41	59	046924	39	0600-2448-41	46	0864-41	47
0332-D	63	0394-1AC	58/59	046924-9	39	0600-41	46/79	0952	81/146
0334-B	61	0394-1AC-41	46/58/59	046926	39	0605	78/79	0952-B	81/146
0334-S	61	0394-6-1A	59	04697	35	0620	78/79	0953	81/144/146
0335-B	61	0394-6-1A-41	59	04697-4	35	0625	78/79	101-14	157
0335-S	61	0394-6-1AC	59	04697-9	35	0640	78/139	105-14	157
0336	63	0394-6-1AC-41	59	04697-BL	35	0640-2436	139	110-1	156
0338	63	0397	58/60	0472	112	0640-3036	139	110-13	156

MODEL	PAGE	MODEL	PAGE	MODEL	PAGE	MODEL	PAGE	MODEL	PAGE
120	156	204692AC	29	64623-00	10	7308	118/120/138	8026	78/80
123	156	204692AC-6	29	64623-41	10	7311-B	135	8091	143
127	157	204692AC-9	29	64623-41PC	44/27	7312	118/120/138	8154	146
128-1	154/156	2046921A	29	64623-9-41PC	44/27	7314	102/138	8155	146
129	157	2046921A-6	29	6467	10/16/18	7314-H	102/139	8156	146
130	157	2046921A-9	29	6467-41PC	18/44	7316	102/139	8165	40/57
140	157	2046921AC	29	6467-9	18	7317	69/138	8202	133
159	156	2046921AC-6	29	6467-9-41PC	18/44	7317-S	69/138	8203	132
162	156	2046921AC-9	29	6467-00	10	7320	131	8204	132
164	156	20470	30/113	6467-41	10	7320-B	131	8205-L	133
165	156	20477-SM	30/109	64672	22	7320-S	131	8205-R	133
167	156	20650	31/78/79	64672-41PC	22/45	7322	141	8206-L	133
169	156	20650-B	78/79	64672-1	11/22	7335	131	8206-R	133
1000	41/68	20655	31/78/79	64672-1-00	11	7335-B	131	8206-SC-L	133
1000A	41/68	20655-1830	31	64672-1-41	11	7335-S	131	8206-SC-R	133
1001	37	20655-1836	31	64672-2	22	7340-B	120	8207	132
1002	37/56	20655-2436	31	64676	18	7340-S	120	8208-L	132
1003	40/68	20692	31/88/90/91	64676-2	18	7340-41	49/120	8208-R	132
1005	56	20826	27/69	64676-9	18	7345-B	121	8209	133
1200-SHU	130/132	20826-T	27/69	6468	23/94	7345-S	121	8215-3	153
1200-V	130/132	20852	30/113	64684	23/94	7355	135	8215-4	153
1201-A	128/130/142	3400 SERIES	115	646924A	21	7355-B	135	8215-5	153
1201-B	130/142	3500 SERIES	115	646924A-9	21	7355-S	135	8287	80
1201-41	130/142	3700 SERIES	115	646924AC	21	7355-24-41	49/135	8338	81/147
1204-1	130	3700-W	115	646924AC-9	21	7360-B	134	8339	81/147
1204-2	130	3800 SERIES	115	64696	22	7360-S	134	8340	81/147
1204-C	130	3800-W	115	64696-6	22	7380-B	134	8358	132
1214	130	3801-41	48/115	64696-9	22	7380-S	134	8370	57
1224	130	3801-18-41	48/115	64696A	11/20	7381	140	8374	57
1224-C	130	3801-24-41	48/115	64696A-6	20	7382-B	121	8425	122
1306	123/152	3801-36-41	48/115	64696A-9	20	7382-S	121	8522	40/57
1307-3	150/152	3801-42-41	48/115	64696A-00	11	7383	136/140	8523A	38/40/55/57
1307-4	152	3874	116	64696A-41	11	7385-B	134	8523AC	38/40/55/57
1307-5	152	3874-M2337	116	64696AC	11/20	7385-S	134	8524	55
1307-6	152	5001-SS	64	64696AC-6	20	7385-41	49/134	9012	84
1308-3	152	6452	19/52	64696AC-9	20	7387	140	9013	87
1308-4	152	6452-9	19/52	64696AC-00	11	7402-B	100	9013-9	87
1315-3	153	645210A	11/20/54	64696AC-41	11	7402-BSM	100	9014	82/84
1315-4	153	645210A-6	20/54	6471	23/113	7402-HB	100	9014-41	47/84
1315-6	153	645210A-9	20/54	6474	20/66/71	7402-HBSM	100	9015	84
20030	30/98	645210A-00	11	6474-00	10/71	7402-HS	100	9017	86
20031	30/98	645210A-41	11	6474-2	20/71	7402-HSSM	100	9017-9	86
20199	31/75	645210AC	11/20/54	6474-2-41PC	20/46/71	7402-S	100	9018	87
20210	27/52	645210AC-6	20/54	6474-41	10	7402-SSM	100	9018-41	47/86
20334	62	645210AC-9	20/54	6474-41PC	20/46/71	74022-B	101	9018-9	82/87
20363	27/62	645210AC-00	11/53/54	6477	23/106/109	74022-BSM	101	9018-9-41	86
20364	27/62	645210AC-41	11/53/54	6477-9	109	74022-H	96	9020	85
20365	27/62	645224-6	21/55	68523A	21/54	74022-HBSM	101	9022	85
20452	28/50/54	645224-9	21/55	68523A-4	21/54	74022-HS	101	9024-41	82/85
204523A	30/55	645224A	55	68523AC	21/54	74022-HSSM	101	9026-41	85
204523A-6	30/55	645224A-6	21/55	68523AC-4	21/54	74022-S	101	9343	27/64
204523A-9	30/55	645224AC	21/55	7301-B	121	74022-SSM	101	9343-41	27/42/46/64
204523AC	30/55	645224AC-6	21/55	7301-S	121	7403-B	101	R-002	104
204523AC-6	30/55	645224AC-9	21/55	7303-B	101	7403-S	101	R-003	105
204523AC-9	30/55	6457	10/19/52	7303-S	101	7404-B	130	R-004	105
20458	28/70	6457-00	10/53	7304-41	18	7404-S	130	R-005	105
204623	26	6457-41	10/53	7305-2B	102	7410-B	130	R-009	105
204623-9	26	6459	19/71	7305-2S	102	7410-S	130		
204684	31/95	6462	11/18	7305-B	101	7801 SERIES	114/115		
204684-9	31/95	6462-2	18	7305-S	101	7801-18	115		
20469	24/26/32	6462-9	18	7305-41	48/101	7801-24	115		
20469-9	26	6462-00	11	7305-2-41	48/102	7801-36	115		
204692A	29	6462-41	8/11	7306	134/141	7801-42	115		
204692A-6	29	64623	10/19	7307-18	135/141	8010	103		
204692A-9	29	64623-9	19	7307-24	135/141	8020	104		



441 Saw Mill River Rd.
Yonkers, NY 10701
Phone: 914.476.9000
Web: americanspecialties.com

© 2026 American Specialties, Inc., an ASI Group Company